

STIHL 038

**Instruction Manual
Owner's Manual**

**Assembling
Safety Precautions
Operating Instructions
Maintenance**



Warning:
Always follow safety precautions in
Owner's Manual – improper use
can cause serious injury!

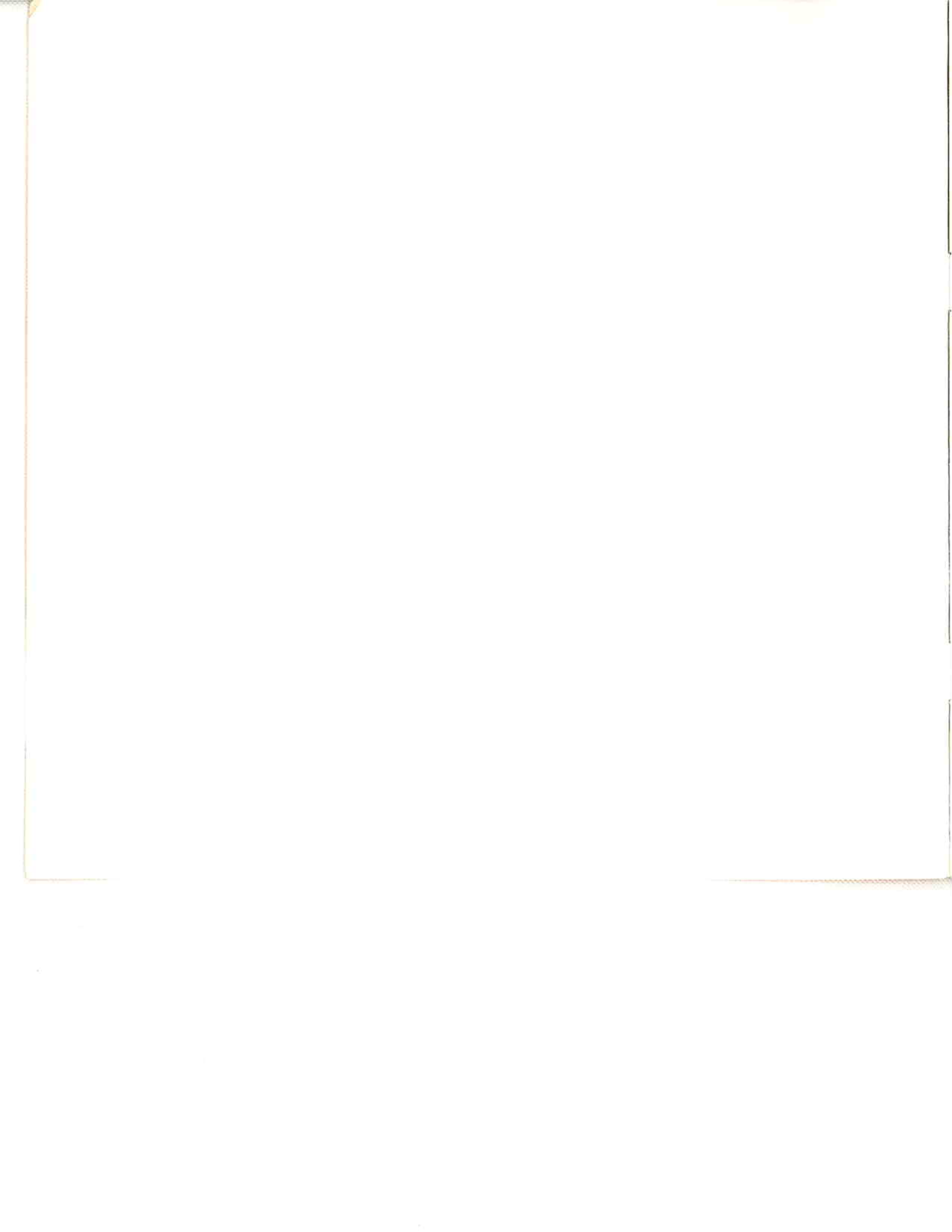

Contents

Main Parts of the Saw	2
Definitions	3
Safety Precautions	4
- The Operator	4
- The Saw	6
- The Use of the Saw	6
- Maintenance, Repair and Storing	21
Fuel	22
Chain Oil	23
Mounting the Bar and Chain	24
Oil Quantity Control	26
Chain Brake	27
Notes on Operation	28
Master Control	29
Starting	30
Electrically Heated Handles	32

Intake Air Preheating	33
Guide Bar, Chain and Sprocket	34
Air Filter	36
Carburetor	37
Replacing the Chain Sprocket Starter Assembly	39
Maintaining and Sharpening Saw Chain	43
Maintenance Chart	50
Specifications	51
Ordering Spare Parts	53
Certificate of Conformity for Europe	54
Quality Certification	54
For Canada only:	
Cutting Attachment	52
Important Safety Precautions	55
Key to Symbols	56

This Manual contains operating and safety instructions for all STIHL 038 series power saws. Pay special attention to the safety precautions outlined on pages 4 to 21. Allow only persons who understand this Manual to operate your chain saw.

To receive maximum performance and satisfaction from your STIHL chain saw, it is important that you read and understand the maintenance and safety precautions before using your saw. Contact your STIHL dealer or the STIHL distributor for your area if you do not understand any of the instructions in this Manual.

Warning!

Because a chain saw is a high-speed wood-cutting tool, some special safety precautions must be observed as with any other power saw to reduce the risk of personal injury. Careless or improper use may cause serious or even fatal injury.

STIHL's philosophy is to continually improve all of its products. As a result, engineering changes and improvements are made from time-to-time. If the operating characteristics or the appearance of your saw differs from those described in this Manual, please contact your STIHL dealer for informations and assistance.

STIHL®



Printed on chlorine-free paper
Printing inks contain vegetable oils,
paper is recyclable

© 1996 Andreas Stihl, Waiblingen
0458 1210121. M5. D6. T. Printed in Germany

X

Parts of the Chain Saw

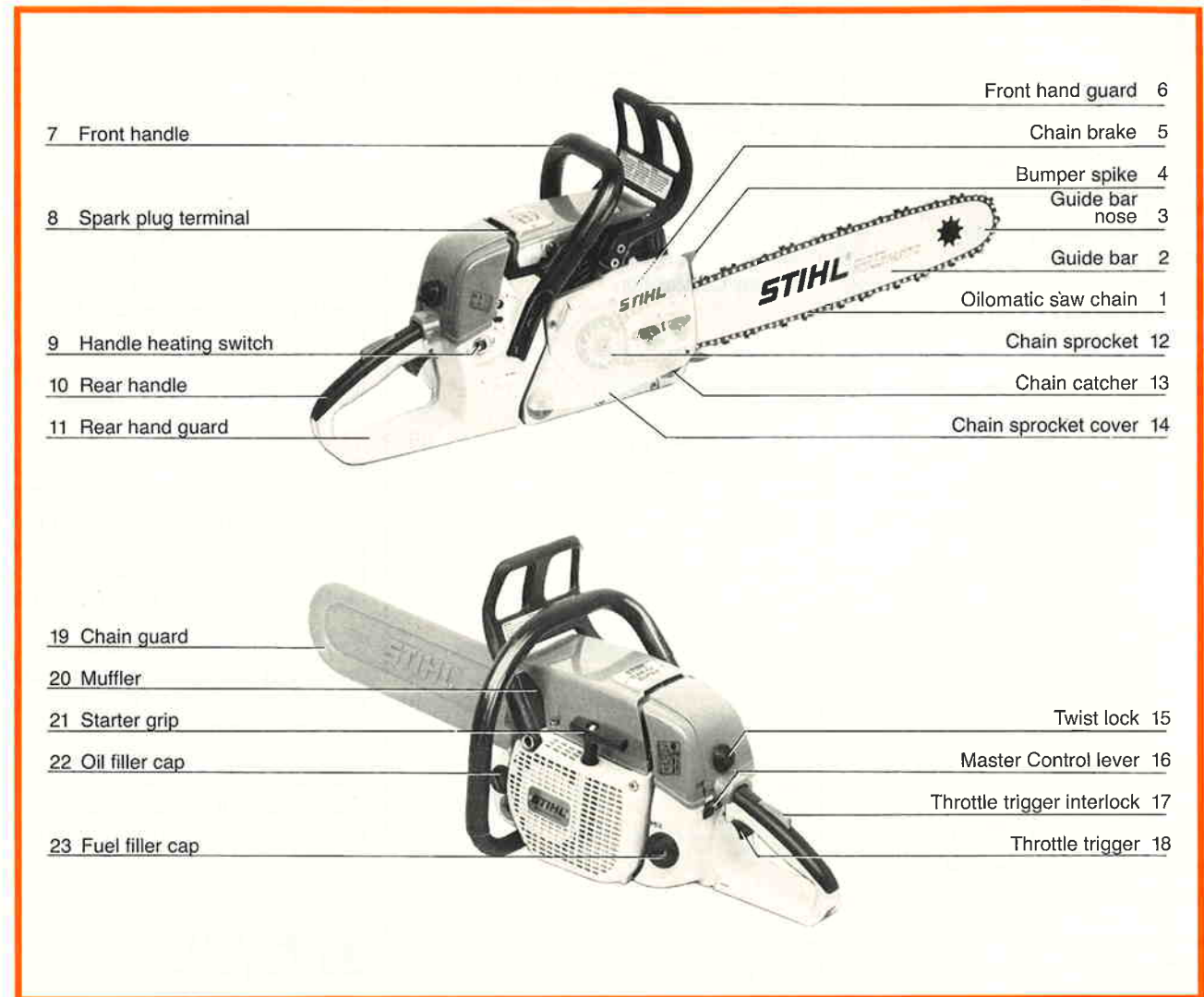

Definitions

1. **Oilomatic Saw Chain.** A loop of chain having cutters, tie straps and drive links.
 2. **Guide Bar.** Supports and guides the saw chain.
 3. **Guide Bar Nose.** The exposed end of the guide bar.
 4. **Bumper Spike.** Toothed stop for holding saw steady against wood.
 5. **Chain Brake.** A device to stop the rotation of the chain if activated in a kickback situation by the operator's hand or by inertia.
 6. **Front Hand Guard.** Provides protection against projecting branches and helps prevent the left hand from touching the chain if it slips off the handle bar.
 7. **Front Handle.** Handle bar for the left hand at front of saw.
 8. **Spark Plug Terminal.** Connects the spark plug with the ignition wire.
 9. **Handle Heating Switch.** For switching the electric handle heating on and off.
 10. **Rear Handle.** The support handle for the right hand, located at or toward the rear of the saw.
 11. **Rear Hand Guard.** Gives added protection to operator's right hand.
 12. **Chain Sprocket.** The toothed wheel that drives the saw chain.
 13. **Chain Catcher.** Helps to reduce the risk of operator contact by a chain when it breaks or comes off the bar.
 14. **Chain Sprocket Cover.** Covers the clutch and the sprocket.
 15. **Twist Lock.** Lock for carburetor box cover.
 16. **Master Control Lever.** Lever for choke control, starting throttle, run and stop switch position.
 17. **Throttle Trigger Interlock.** Must be depressed before the throttle trigger can be activated.
 18. **Throttle Trigger.** Controls the speed of the engine.
 19. **Chain Guard (Scabbard).** Covers the bar and the chain when the saw is not in use.
 20. **Muffler.** Reduces engine exhaust noise and directs the exhaust gases.
 21. **Starter Grip.** The grip of the starter, for starting the engine.
 22. **Oil Filler Cap.** For closing the oil tank.
 23. **Fuel Filler Cap.** For closing the fuel tank.
- Clutch.** Couples engine to chain sprocket when engine is accelerated beyond idle speed.
(Not illustrated.)
- Anti-Vibration System.** The anti-vibration system includes a number of buffers designed to reduce the transmission of vibrations created by the engine and cutting attachment to the operator's hands.
(not illustrated).

Safety Precautions



The use of any chainsaw may be hazardous. The saw chain has many sharp cutters. If the cutters contact your flesh,

they will cut you, even if the chain is not moving. At full throttle, the chain speed can reach 45 mph (20 m/s). It is important that you read, fully understand and observe the following safety precautions and warnings. Read the Owner's Manual **and** the safety instructions periodically.

Pay special attention to the section on reactive forces.

Warning!

Reactive forces, including kickback, can be dangerous. Careless or improper use of any chainsaw may cause serious or fatal injury.

All safety precautions that are generally observed when working with an axe or a hand saw also apply to the operation of chainsaws. However, because a chainsaw is a high-speed, fast-cutting power tool, special safety precautions must be observed to reduce the risk of personal injury.

Have your STIHL dealer show you how to operate your chainsaw. Observe all applicable local safety regulations, standards and ordinances.

Warning!

Minors should never be allowed to use a chainsaw. Bystanders, especially



000BA036 LA

children, and animals should not be allowed in the area where a chainsaw is in use. Never let the saw run unattended. Store it in a locked place away from children and empty the fuel tank before storing for longer than a few days.



Do not lend or rent your chainsaw without the Owner's Manual. Be sure that anyone using your saw reads and understands the information contained in this manual.

These safety precautions and warnings apply to the use of all STIHL chainsaws. Different models may have different parts and controls. See the appropriate



000BA037 LA

section of your Owner's Manual for a description of the controls and function of the parts of your model saw.

Safe use of a chainsaw involves

1. the operator
2. the saw
3. the use of the saw.

THE OPERATOR

Physical Condition

You must be in good physical condition and mental health and not under the influence of any substance (drugs, alcohol) which might impair vision, dexterity or judgment.

Do not operate a chainsaw when you are fatigued. Be alert – If you get tired while operating your chainsaw, take a break. Tiredness may result in loss of control. Working with any chainsaw can be strenuous. If you have any condition that might be aggravated by strenuous work, check with your doctor before operating a chainsaw.

Warning!

Prolonged use of chainsaws (or other machines) exposing the operator to vibrations may produce whitefinger disease (Raynaud's phenomenon) or carpal tunnel syndrome. These conditions reduce the hand's ability to feel and regulate temperature, produce numbness and burning sensations and may cause nerve and circulation damage and tissue necrosis.

Many STIHL models are available with an anti-vibration (AV) system designed to reduce the transmission of vibrations created by the engine and cutting attachment to the operator's hands. An anti-vibration system is recommended for those using chainsaws on a regular or sustained basis.

Heated handles help to reduce the risk of whitefinger disease and are recommended for cold weather use. Most STIHL powerheads are available with heated handles.



Anti-vibration systems and heated handles do not guarantee that you will not sustain whitefinger disease or carpal tunnel syndrome. Therefore, continual and regular users should monitor closely the condition of their hands and fingers. If any of the above symptoms appear, seek medical advice immediately.

Proper Clothing

Clothing must be sturdy and snug-fitting, but allow complete freedom of movement. Avoid loose-fitting jackets, scarfs, neckties, jewelry, flared or cuffed pants, unconfined long hair or anything that could become entangled with the saw or brush. Wear overalls or jeans with a reinforced cut retardant insert.

Protect your hands with gloves when handling saw and saw chain. Heavyduty, nonslip gloves improve your grip and protect your hands.

Good footing is most important in chainsaw work. Wear sturdy boots with nonslip soles. Steel-toed safety boots are recommended.

To reduce the risk of injury to your eyes never operate a chainsaw unless wearing goggles or properly fitted safety glasses with adequate top and side protection complying with your national standard.



Wear an approved safety hard hat to protect your head. chainsaw noise may damage your hearing. Always wear sound barriers (ear plugs or ear muffers) to protect your hearing. Continual and regular users should have their hearing checked regularly.

THE SAW

Parts of the chainsaw; for illustrations and definitions of the parts see the chapter on "Main Parts of Saw".

Warning!

Never modify a chainsaw in any way. Only attachments and parts supplied by STIHL or expressly approved by STIHL for use with the specific STIHL saw models are authorized. Although certain unauthorized attachments are useable with the STIHL powerhead, their use may, in fact, be extremely dangerous.

THE USE OF THE SAW

Transporting the chainsaw

Warning!

Always stop the engine before putting a chainsaw down or carrying it. Carrying a chainsaw with the engine running is extremely dangerous. Accidental acceleration of the engine can cause the chain to rotate. During operation, the powerhead muffler and the material around it reach extremely high temperatures. Avoid touching the hot muffler, you could receive serious burns.

By hand: When carrying your saw by hand, the engine must be stopped and the saw must be in the proper position.



Grip the front handle and place the muffler away from the body.

The chain guard (scabbard) should be over the chain and the guide bar, which should point backwards. When carrying your saw, the bar should be behind you.

By vehicle: When transporting in a vehicle, keep chain and bar covered with the chain guard. Properly secure your saw to prevent turnover, fuel spillage and damage to the saw.

Preparation for the use of the saw

Take off the chain guard and inspect for safety in operation. For assembly, follow the procedure described in the chapter "Mounting the Bar and Chain" of your Owner's Manual.

STIHL Oilomatic chain, guide bar and sprocket must match each other in gauge and pitch.

Before replacing any bar and chain, see the sections on "Specifications", kickback and the ANSI B 175.1-1991 chain-saw kickback standard in this manual.

Warning!

Proper tension of the chain is extremely important. In order to avoid improper setting, the tensioning procedure must be followed as described in your manual. Always make sure the hexagonal nut(s) for the sprocket cover is (are) tightened securely after tensioning the chain. Never start the saw with the sprocket cover loose. Check chain tension once more after having tightened the nut(s) and thereafter at regular intervals (whenever the saw is shut off). If the chain becomes loose while cutting, shut off the engine and then tighten. Never try to tighten the chain while the engine is running!

Fueling

Your STIHL chainsaw uses an oil-gasoline mixture for fuel (see chapter "Fuel" of your Owner's Manual).

Warning!

Gasoline is an extremely flammable fuel. If spilled or ignited by a spark or other ignition source, it can cause fire and serious burn injury or property damage. Use extreme caution when handling gasoline or fuel mix.



Do not smoke or bring any fire or flame near the fuel.

Fueling Instructions

Fuel your chainsaw in well-ventilated areas, outdoors only.

Always shut off the engine and allow it to cool before refueling. Gasoline vapor pressure may build up inside the gas-tank of a two cycle engine depending on the fuel used, the weather conditions, and the venting system of the tank. In order to reduce the risk of burns or other personal injury from escaping gas vapor and fumes, remove the gas cap on the STIHL product carefully so as to allow any pressure build-up in the tank to release slowly. Never remove fuel filler cap while engine is running.

Select bare ground for fueling and move at least 10 feet (3 m) from fueling spot before starting the engine. Wipe off any spilled fuel before starting your saw, and check for leakage.

Check for fuel leakage while refueling and during operation. If fuel or oil leakage is found, do not start or run the engine until leak is fixed and spilled fuel has been wiped away. Take care not to get fuel on your clothing. If this happens, change your clothing immediately.

Warning!

Unit vibrations can cause an improperly tightened fuel cap to loosen or come off and spill quantities of fuel. In order to reduce risk of fuel spillage and fire, tighten fuel cap by hand with as much force as possible.

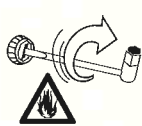

The screw driver end of the STIHL combination wrench or other similar tool can be used as an aid in tightening slotted fuel caps.

Starting

The chain brake must be blocked when starting the saw

Warning!

Your chainsaw is a one-person saw. Do not allow other persons to be near the running chainsaw. Start and operate your saw without assistance. For specific starting instructions, see the appropriate section of the Owner's Manual. Proper starting methods reduce the risk of injury.

Do not drop start. This method is very dangerous because you may lose control of the saw.

There are two recommended methods for starting your chainsaw.



With the **first method**, the chainsaw is started on the ground. Engage the chain brake (see "Chain Brake" chapter in your Owner's Manual) and place the chainsaw on firm ground or other solid surface in an open area. Maintain good balance and secure footing.

Grip the front handlebar of the saw firmly with your left hand and press down. For saws with a rear handle level with the ground, put the toe of your right foot into the rear handle and press down.

With your right hand pull out the starter grip slowly until you feel a definite resistance and then give it a brisk, strong pull.

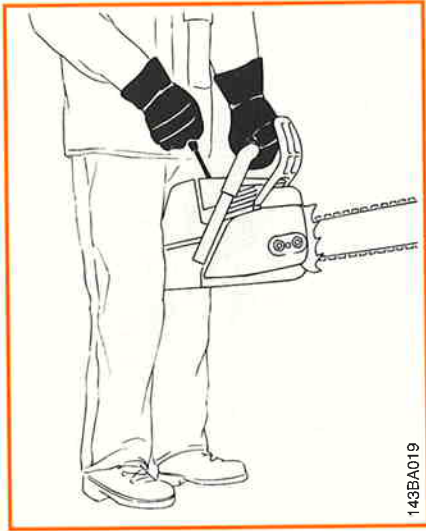

143BA019

The **second** recommended **method** for starting your chainsaw allows you to start the saw without placing it on the ground. Engage the chain brake, grip the front handle of the chainsaw firmly with your left hand. Keep the arm on the front handle in a locked (straight) position. Hold the rear handle of the saw tightly between your legs just above the knees. Maintain good balance and secure footing. Pull the starting grip slowly with your right hand until you feel a definite resistance and then give it a brisk, strong pull.

Warning!

Be sure that the guide bar and chain are clear of you and all other obstructions and objects, including the ground. When the engine is started, the engine speed

with the starting throttle lock engaged will be fast enough for the clutch to engage the sprocket and turn the chain. If the upper quadrant of the bar nose touches any object, it may cause kick-back to occur (see section on reactive forces). To reduce this risk, always engage the chain brake before starting. Never attempt to start the chainsaw when the guide bar is in a cut or kerf. When you pull the starter grip, do not wrap the starting rope around your hands. Do not allow the grip to snap back, but guide the starter rope slowly back to permit the rope to rewind properly. Failure to follow this procedure may result in injury to hand or fingers and may damage the starter mechanism.

Important adjustments

Warning!

To reduce the risk of personal injury from loss of control or contact with the running chain, do not use a saw with incorrect idle adjustment. At correct idle speed, the chain should not rotate. For directions on how to adjust idle speed, see the appropriate section of your Owner's Manual. If you cannot set the correct idle speed, have your STIHL dealer check your saw and make proper adjustments or repairs. After adjusting a chain, start the saw, let the engine run for a while, then switch engine off and recheck chain tension. Proper chain tension is very important at all times.

Working Conditions

Operate your chainsaw outdoors only in a ventilated area, even if your chainsaw is equipped with a catalytic converter. The muffler and other parts of the engine (e.g. fins of the cylinder, spark plug) become hot during operation and remain hot for awhile after stopping the engine. To reduce risk of burns do not touch the muffler and other parts while they are hot. Operate the saw under good visibility and daylight conditions only.

Don't work alone. Keep within calling distance of others in case help is needed.

Your chainsaw is equipped with a chain catcher. It is designed to reduce the risk of personal injury in the event of a thrown or broken chain. From time to time the catcher may be damaged or removed. To reduce the risk of personal injury, do not operate a chainsaw with a damaged or missing catcher.

Inspect buffers periodically. Replace damaged, broken or excessively worn buffers immediately, since they may result in loss of control of the saw. A "sponginess" in the feel of the saw, increased vibration or increased "bottoming" during normal operation may indicate damage, breakage or excessive wear. Buffers should always be replaced in sets. If you have any questions as to whether the buffers should be replaced, consult your STIHL servicing dealer.

Warning!

Take extreme care in wet and freezing weather (rain, snow, ice). Put off the work when the weather is windy, stormy or rainfall is heavy. Clear the area where you are working.

Warning !

Avoid stumbling on obstacles such as stumps, roots or rocks and watch out for holes or ditches. Be extremely cautious when working on slopes or uneven ground. There is increased danger of slipping on freshly debarked logs.



Warning!

To reduce the risk of serious or fatal injury to the operator or bystanders,

never use the saw with one hand. You cannot control reactive forces and you may lose control of the saw, which can result in the bar and chain skating or bouncing along the limb or log.

Even for those compact saws designed for use in confined spaces, one-handed operation is dangerous because the operator may lose control.

Cutting Instructions

Grip: Always hold the saw firmly with both hands when the engine is running. Place your left hand on front handle bar and your right hand on rear handle and throttle trigger. Left-handers should follow these instructions too.



Wrap your fingers tightly around the handles, keeping the handles cradled between your thumb and forefinger. With your hands in this position, you can best oppose and absorb the push, pull and kickback forces of your saw without losing control (see section on reactive forces). Make sure your chainsaw handles and grip are in good condition and free of moisture, pitch, oil or grease.

Warning!

Do not operate your chainsaw with the starting throttle lock engaged. Cutting with the starting throttle lock engaged does not permit the operator proper control of the saw or chain speed.



Warning!

Never touch a chain with your hand or any part of your body when the engine is running, even when the chain is not rotating. The chain continues to rotate for a short period after the throttle trigger is released.

Warning !

Do not cut any material other than wood or wooden objects. Use your chainsaw for cutting only. It is not designed for prying or shoveling away limbs, roots or other objects.

When sawing, make sure that the saw chain does not touch any foreign materials such as rocks, fences, nails and the like. Such objects may be flung off, damage the



saw chain or cause the saw to kickback. In order to keep control of your saw, always maintain a firm foothold. Never work on a ladder, or on any other insecure support. Never use the saw above shoulder height. Never work in a tree unless you have received specific, professional training for such work, are properly secured (such as tackle and harness system or a lift bucket), have both hands free for operating the chainsaw in a cramped environment and have taken proper precautions to avoid injury from falling limbs or branches. Position the chainsaw in such a way that your body is clear of the cutting attachment whenever the engine is running. Stand to the left of the plane of the cutting attachment.

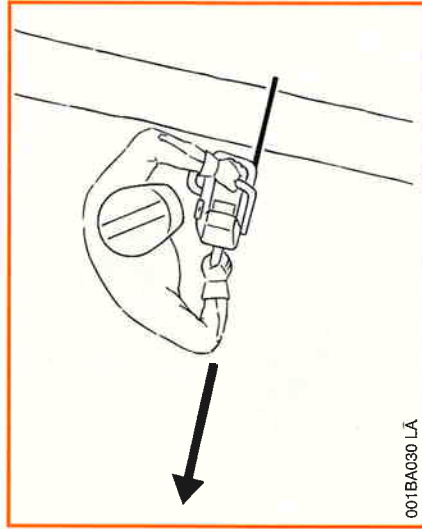

Don't put pressure on the saw when reaching the end of a cut. The pressure may cause the bar and rotating chain to pop out of the cut or kerf, go out of control and strike the operator or some other object. If the rotating chain strikes some other object, a reactive force may cause the moving chain to strike the operator.

Reactive forces including kickback

Warning!

Reactive forces may occur any time the chain is rotating. Reactive forces can be dangerous! In any chainsaw, the powerful force used to cut wood can be reversed (and work against the operator).

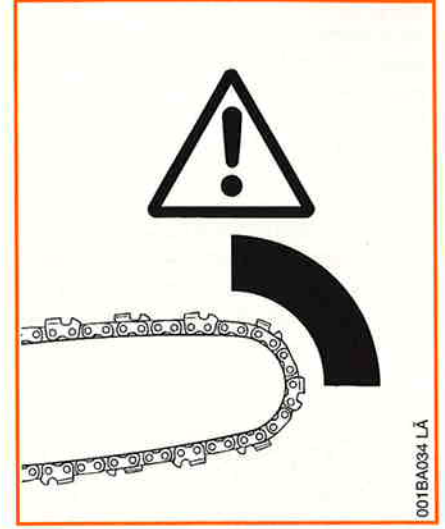

If the rotating chain is suddenly stopped by contact with any solid object like a log or branch or is pinched, the reactive forces may occur instantly. These reactive forces may result in loss of control which may, in turn, cause serious or fatal injury. An understanding of the causes of these reactive forces may help you avoid loss of control.

The most common reactive forces are

- kickback,
- pushback,
- pull-in.

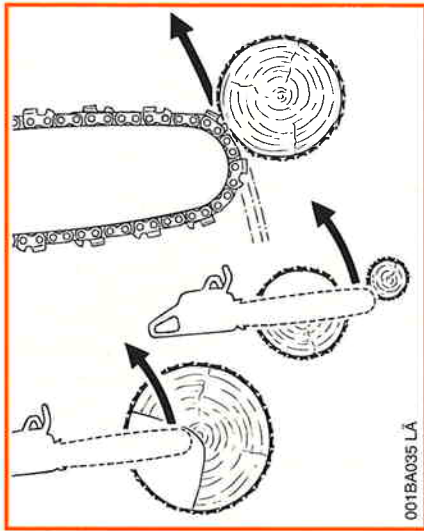

Kickback:



Kickback occurs when the upper quadrant of the bar nose contacts a solid object or is pinched. The reaction of the cutting force of the chain causes

a rotational force on the chainsaw in the direction opposite to the chain movement.

This may fling the bar up and back in an uncontrolled arc mainly in the plane of the bar. Under some cutting circumstances the bar moves towards the operator, who may suffer severe or fatal injury.

Kickback may occur when the nose of the guide bar is pinched unexpectedly, unintentionally contacts solid material in the wood or is incorrectly used to begin a plunge or boring cut. It may also occur during limbing.

The greater the force of the kickback reaction, the more difficult it is for the operator to control the saw.

Many factors influence the occurrence and force of the kickback reaction. These include chain speed, the speed at which the bar and chain contact the object, the angle of contact, the condition of the chain and other factors.

The type of bar and saw chain you use is an important factor in the occurrence and force of the kickback reaction. Some STIHL bar and chain types are designed to reduce kickback forces. STIHL recommends the use of reduced kickback bars and low kickback chains.

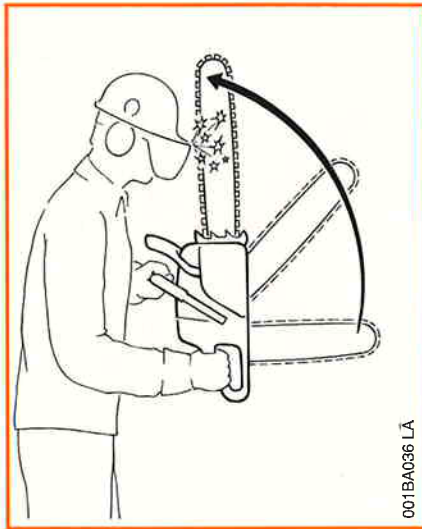

Quickstop chain brake

STIHL has developed a chain stopping system designed to reduce the risk of injury in certain kickback situations. It is called a Quickstop chain brake. The Quickstop is available as standard equipment on your STIHL chainsaw and is available for installation on most older STIHL saws. Ask your dealer to retrofit your older model saw with a chain brake. When a kickback occurs, the guide bar may rotate around the front handle. If the cutting position is such that the operator's left hand is gripping the front handle behind the hand guard, and if the left hand rotates around the front handle and contacts the front hand guard, which is the Quickstop activating lever, this contact will activate the Quickstop. The chain brake on most new model STIHL chainsaws can also be activated by inertia. See the chapter entitled "Chain Brake" of your Owner's Manual.

Warning!

Never operate your chainsaw without a front hand guard. In a kickback situation this guard helps protect your left hand or other parts of your body. In addition, removal of the hand guard on a saw equipped with a chain brake will deactivate the chain brake.

Devices for reducing the risk of kickback injury

STIHL recommends the use of the STIHL Quickstop chain brake on your powerhead with green labeled reduced kickback bars and low kickback chains.

Caution! If the chain brake does not function correctly, stop using the saw immediately.

Risk of injury! Take the saw to your local STIHL Service Centre! Do not use the saw until the fault has been rectified (see the section "Chain Brake")

Warning!

No Quickstop or other chain brake device prevents kickback. These devices are designed to reduce the risk of kickback injury, if activated, in certain kickback situations. In order for the Quickstop to reduce the risk of kickback injury, it must be properly maintained and in good working order. See the chapter entitled "Chain Brake" and "Maintenance, Repair and Storing" of your Owner's Manual. In addition, there must be enough distance between the bar and the operator to ensure that the Quickstop has sufficient time to activate and stop the chain before potential contact with the operator.

Warning!

An improperly maintained chain brake may increase the time needed to stop the chain after activation, or may not activate at all.

Reduced kickback bar

STIHL green labeled reduced kickback bars are designed to reduce the risk of kickback injury when used with STIHL green labeled low kickback chains.

Warning!

When used with other, more aggressive chains, these bars may be less effective in reducing kickback, and may result in higher kickback forces.

Low kickback chain

Some types of saw chain have specially designed components to reduce the force of nose contact kickback. STIHL has developed low kickback chain for your powerhead.

Warning!

A dull or improperly sharpened chain may reduce or negate the effects of the design features intended to reduce kickback energy. Improper lowering or sharpening of the depth gauges or shaping of the cutters may increase the chance and the potential energy of a kickback. Always cut with a properly sharpened chain.

Warning!

Reduced kickback bars and low kickback chains do not prevent kickback, but they are designed to reduce the risk of kickback injury. They are available from your STIHL dealer.

Warning!

Even if your saw is equipped with a Quickstop, a reduced kickback bar and/or low kickback chain, this does not eliminate the risk of injury by kickback. Therefore, always observe all safety precautions to avoid kickback situations.

To avoid kickback

The best protection from personal injury that may result from kickback is to avoid kickback situations:

1. Hold the chainsaw firmly with both hands and maintain a secure grip.
2. Be aware of the location of the guide bar nose at all times.
3. Never let the nose of the guide bar contact any object. Do not cut limbs with the nose of the guide bar. Be especially careful when cutting small, tough limbs, small size brush and saplings which may easily catch the chain.
4. Don't overreach.
5. Don't cut above shoulder height.
6. Begin cutting and continue at full throttle.
7. Cut only one log at a time.
8. Use extreme caution when re-entering a previous cut.
9. Do not attempt to plunge cut if you are not experienced with these cutting techniques.
10. Be alert for shifting of the log or other forces that may cause the cut to close and pinch the chain.
11. Maintain saw chain properly. Cut with a correctly sharpened, properly tensioned chain at all times.
12. Stand to the side of the cutting path of the chainsaw.

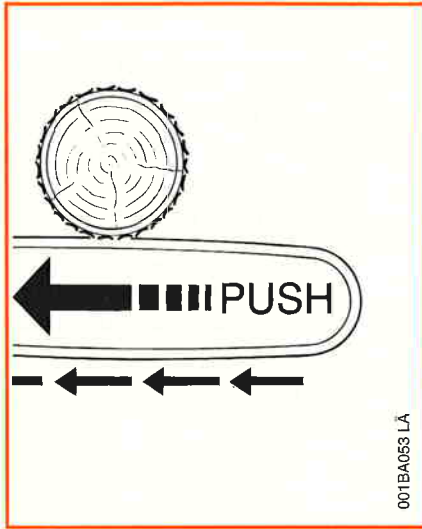

Pushback:

Pushback occurs when the chain on the top of the bar is suddenly stopped when it is pinched, caught or encounters a foreign object in the wood. The reaction of the chain drives the saw straight back toward the operator and may cause loss of saw control. Pushback frequently occurs when the top of the bar is used for cutting.

To avoid pushback

1. Be alert to forces or situations that may cause material to pinch the top of the chain.

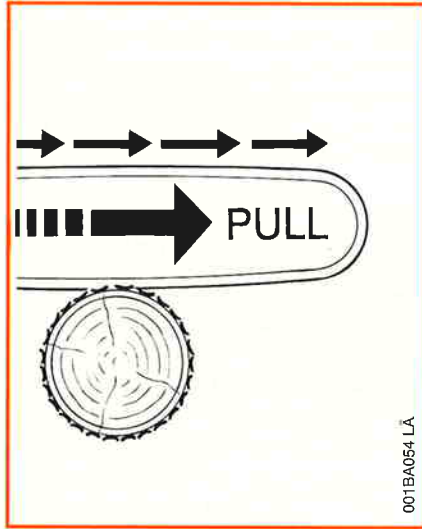

2. Do not cut more than one log at a time.
3. Do not twist the saw when withdrawing the bar from a plunge cut or underbuck cut because the chain can pinch.

Pull-in:

Pull-in occurs when the chain on the bottom of the bar is suddenly stopped. The chain on the bottom of the bar stops when it is pinched, caught or encounters a foreign object in the wood. The reaction of the chain pulls the saw forward and may cause the operator to lose control.

Pull-in frequently occurs when the bumper spike of the saw is not held securely against the tree or limb and when the chain is not rotating at full speed before it contacts the wood.

Warning!

Use extreme caution when cutting small size brush and saplings which may easily catch the chain and pull you off balance.

To avoid pull-in

1. Always start a cut with the chain rotating at full speed and the bumper spike in contact with the wood.
2. Pull-in may also be prevented by using wedges to open the kerf or cut.

Cutting Techniques

Felling

Felling is cutting down a tree.

Before felling a tree, consider carefully all conditions which may affect the direction of fall, including:

The intended direction of the fall.

The natural lean of the tree.

Any unusually heavy limb structure.

Surrounding trees and obstacles.

The wind direction and speed.

Warning!

Always observe the general condition of the tree. Inexperienced users should never attempt to cut trees which are decayed or rotted inside or which are leaning or otherwise under tension. There is an increased risk that such trees could snap or split while being cut and cause serious or fatal injury to the operator or bystanders.

Also look for broken or dead branches which could vibrate loose and fall on the operator. When felling on a slope, the operator should stand on the uphill side if possible.

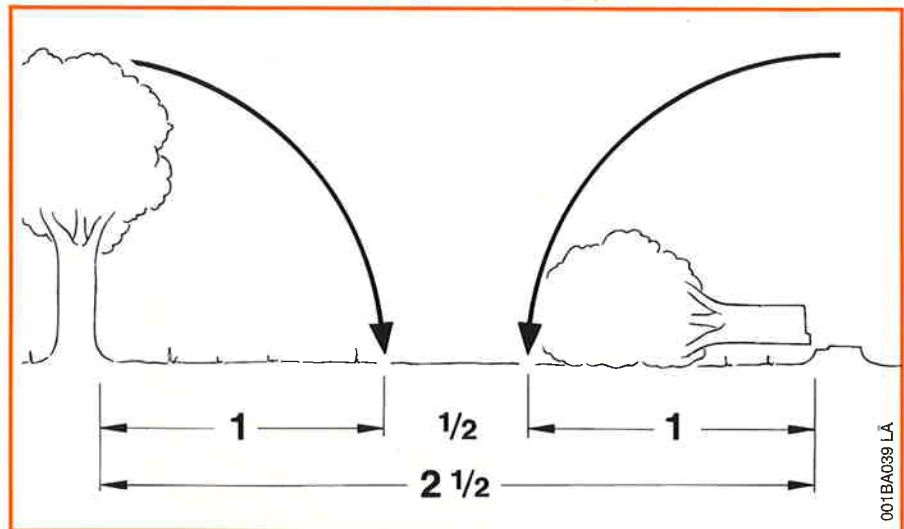

When felling in the vicinity of roads, railways and power lines, etc., take extra precautions. Inform the police, utility company or railway authority before beginning to cut.

When felling, maintain a distance of at least $2\frac{1}{2}$ tree lengths from the nearest person.

Note:

The noise of your engine may drown any warning call.

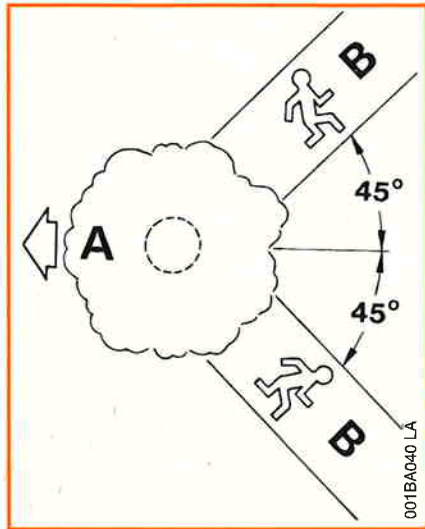

Felling Instructions:

First clear the tree base and work area from interfering limbs and brush and clean its lower portion with an axe.

Then, establish two paths of escape (B) and remove all obstacles. This paths should be generally opposite to the planned direction of the fall of the tree (A) and about at a 45° angle. Place all tools and equipment a safe distance away from the tree, but not on the escape paths.

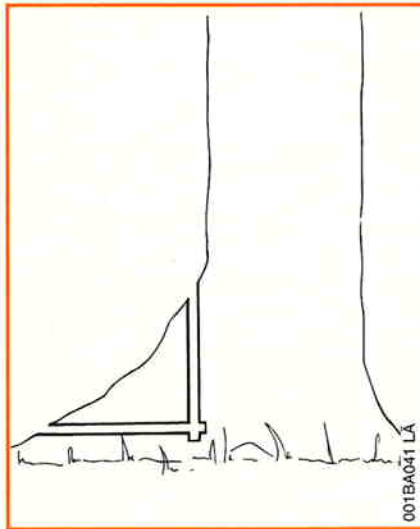

If the tree has large buttress roots, cut into the largest buttress vertically first (horizontally next) and remove the resulting piece.

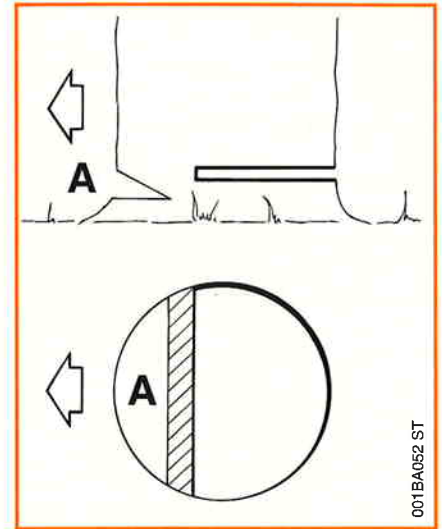

Conventional cut

A = felling notch – determines the direction of the fall

For a conventional cut:

- Properly place felling notch perpendicular to the line of fall, close to the ground
- Cut down at app. 45-degree angle to a depth of about 1/2 to 1/4 of the trunk diameter
- Make second cut horizontal
- Remove resulting 45-degree piece.

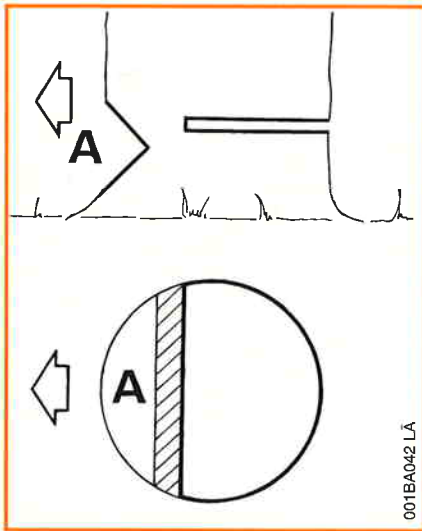

001BA042 LA

Open-face technique

A = felling notch – determines the direction of the fall

For an open-face cut:

- Properly place felling notch perpendicular to the line of fall, close to the ground
- Cut down at app. 50-degree angle to a depth of app. 1/5 to 1/4 of the trunk diameter
- Make second cut from below at app. 40 degree angle
- Remove resulting 90-degree piece.

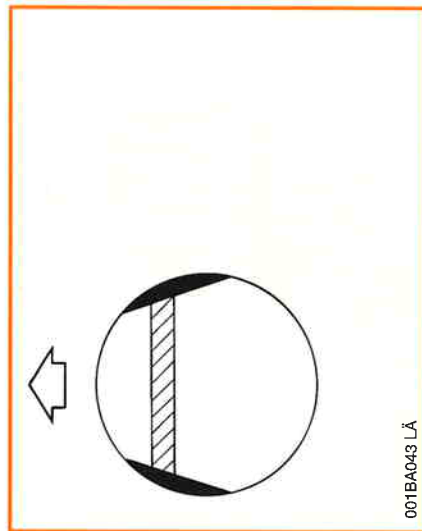

001BA043 LA

Making sapwood cuts

- For medium sized or larger trees make cuts at both sides of the trunk
- at same height as subsequent felling cut
- Cut to no more than width of guide bar.

This is especially important in soft wood in summer – it helps prevent sapwood splintering when the tree falls.

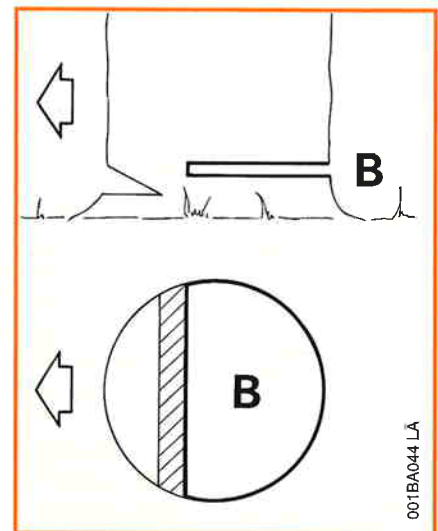

001BA044 LA

B = Felling cut

Conventional and open-face technique:

- Begin 1 to 2 inches higher than center of felling notch
- Cut horizontally towards the felling notch
- Leave approx. 1/10 of diameter uncut. This is the hinge
- Do not cut through the hinge – you could lose control of the direction of the fall.

Drive wedges into the felling cut where necessary to control the fall.

Warning!

If the tip of the bar contacts a wedge, it may cause kickback.

Wedges should be of wood or plastic – never steel, which can damage the chain.

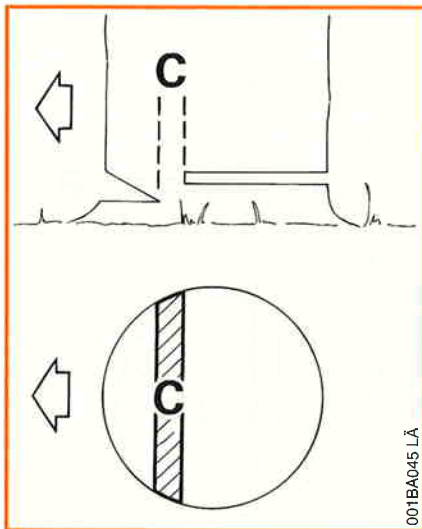

C = Hinge

- Helps control the falling tree
- Do not cut through the hinge – you could lose control of the direction of the fall .

Warning!

In order to reduce the risk of personal injury, never stand directly behind the tree when it is about to fall, since part of the trunk may split and come back towards the operator (barber-chairing), or the tree may jump backwards off the stump. Always keep to the side of the falling tree. When the tree starts to fall, withdraw the bar, shut off the engine and walk away on the preplanned escape path. Watch out for falling limbs.

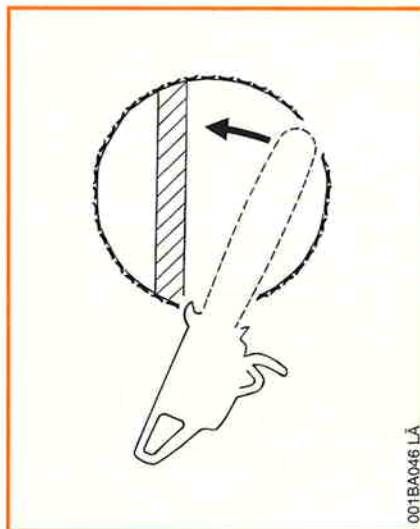

Warning!

Be extremely careful with partially fallen trees which are poorly supported. When the tree hangs or for some other reason does not fall completely, set the saw aside and pull the tree down with a cable winch, block and tackle or tractor. If you try to cut it down with your saw, you may be injured.

Felling cut for small diameter trees: simple fan cut

Engage the bumper spikes of the chain-saw directly behind the hinge and pivot the saw around this point only as far as the hinge. The spiked bumper rolls against the trunk.

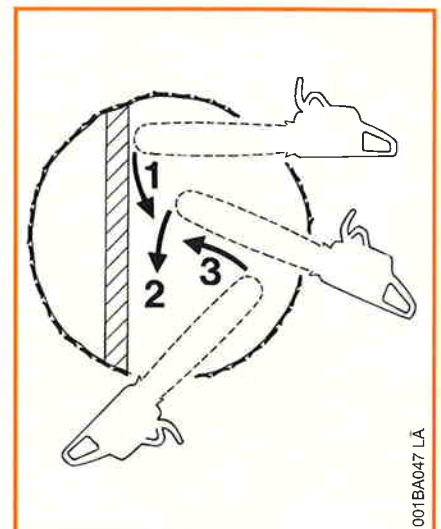

Felling cut for large diameter trees: sectioning method

Warning!

Felling a tree that has a diameter greater than the length of the guide bar requires use of either the sectioning felling cut or plunge-cut method. These methods are extremely dangerous because they involve the use of the nose of the guide bar and can result in kickback. Only properly trained professionals should attempt these techniques.

For the sectioning method make the first part of the felling cut with the guide bar fanning in toward the hinge. Then, using the bumper spike as a pivot, reposition the saw for the next cut.

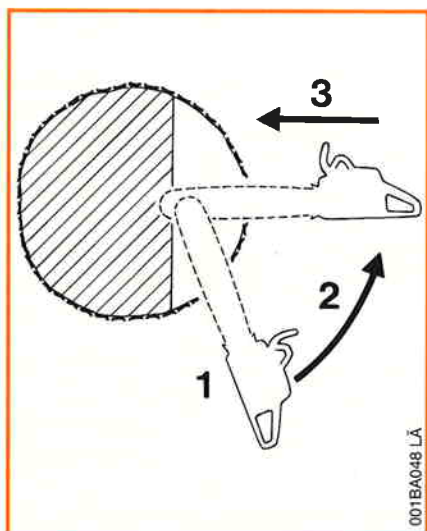

001BA048 LA

Avoid repositioning the saw more than necessary. When repositioning for the next cut, keep the guide bar fully engaged in the kerf to keep the felling cut straight. If the saw begins to pinch, insert a wedge to open the cut. On the last cut, do not cut the hinge.

Plunge-cut method

Timber having a diameter more than twice the length of the guide bar requires the use of the plunge-cut method before making the felling cut.

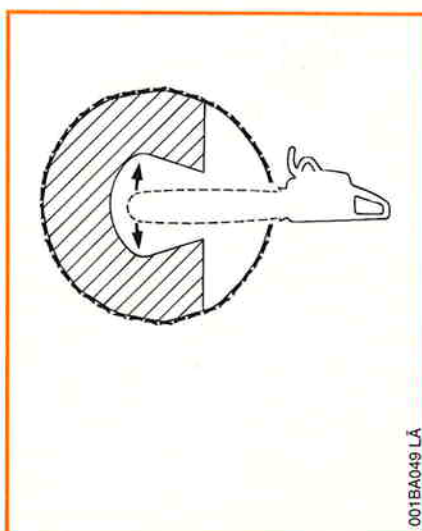

001BA049 LA

First, cut a large, wide felling notch. Make a plunge cut in the center of the notch.

The plunge cut is made with the guide bar nose. Begin the plunge cut by applying the lower portion of the guide bar nose to the tree at an angle. Cut until the depth of the kerf is about the same as the width of the guide bar. Next, align the saw in the direction in which the recess is to be cut.

With the saw at full throttle, insert the guide bar in the trunk.

Enlarge the plunge cut as shown in illustration.

Warning!

There is an extreme danger of kickback at this point. Extra caution must be taken to maintain control of the saw. To make the felling cut, follow the sectioning method described previously. If you are inexperienced with a chainsaw, plunge-cutting should not be attempted. Seek the help of a professional.

Limbing

Limbing is removing the branches from a fallen tree.

Warning!

There is an extreme danger of kickback during the limbing operation. Do not work with the nose of the bar. Be extremely cautious and avoid contacting the log or other limbs with the nose of the guide bar

Do not stand on a log while limbing it – you may slip or the log may roll.

Start limbing by leaving the lower limbs to support the log off the ground. When underbucking freely hanging limbs, a pinch may result or the limb may fall causing loss of control. If a pinch occurs, stop the engine and remove the saw, by lifting the limb.

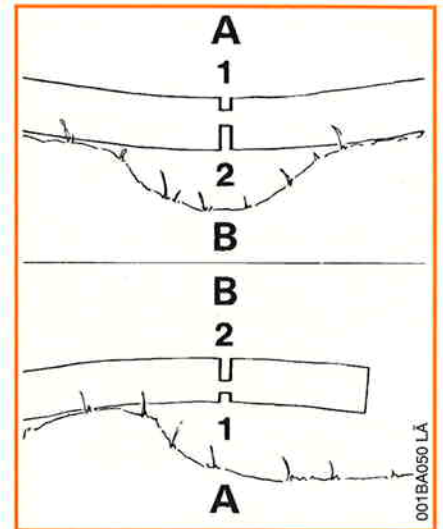

Warning!

Be extremely cautious when cutting limbs or logs under tension (spring poles). The limbs or logs could spring back toward the operator and cause loss of control of the saw and severe or fatal injury to the operator.

Bucking

Bucking is cutting a log into sections.

Warnings!

1. When bucking, do not stand on the log. Make sure the log will not roll downhill. If on a slope, stand on the uphill side of the log. Watch out for rolling logs.

2. Cut only one log at a time.

3. Shattered wood should be cut very carefully. Sharp slivers of wood may be caught and flung in the direction of the operator of the saw.

4. When cutting small logs, place log through "V" - shaped supports on top of a sawhorse. Never permit another person to hold the log. Never hold the log with your leg or foot.

5. Logs under strain: Risk of pinching! Always start relieving cut (1) at compression side (A). Then make bucking cut (2) at tension side (B). If the saw pinches, stop the engine and remove it from the log.

6. Only properly trained professionals should work in an area where the logs, limbs and roots are tangled. Working in blowdown areas is extremely hazardous.

7. Drag the logs into a clear area before cutting. Pull out exposed and cleared logs first.

MAINTENANCE, REPAIR AND STORING

Use only STIHL replacement parts for maintenance and repair. Use of parts manufactured by others may cause serious or fatal injury.

Never operate a chainsaw that is damaged, improperly adjusted or not completely or securely assembled. Follow the maintenance and repair instructions in the appropriate section of your Owner's Manual, especially those in the chapters "Mounting the bar and chain" "Maintaining and Sharpening" and "Chain Brake".

Warning! Always stop the engine and ensure that the chain is stopped before making any adjustments, maintenance or repair work, changing the saw chain or cleaning the saw. Do not attempt any maintenance or repair work not described in your Owner's Manual. Have such work performed at your STIHL service shop only.

Never test the ignition system with ignition wire terminal removed from spark plug or with unseated spark plug, since uncontained sparking may cause a fire.

Warning! To reduce the risk of fire and burn injury, use only spark plugs authorized by STIHL. Always press spark plug boot snugly onto spark plug terminal of the proper size. (Note: If terminal has detachable SAE adapter nut, it must be

attached.) A loose connection between spark plug terminal and ignition wire connector in the boot may create arcing that could ignite combustible fumes and cause a fire. Keep spark plug clean, and make sure ignition lead is in good condition.

Warning! Do not operate your chainsaw if the muffler is damaged, missing or modified. An improperly maintained muffler will increase the risk of fire and hearing loss. Never touch a hot muffler or burn will result. If your muffler was equipped with a spark-arresting screen to reduce the risk of fire (e. g. in the USA, Canada and Australia), never operate your saw if the screen is missing or damaged. Remember that the risk of forest fires is greater in hot or dry weather.

Keep the chain, bar and sprocket clean; replace worn sprockets or chains.

Keep the chain sharp. You can spot a dull chain when easy-to-cut wood becomes hard to cut and burn marks appear on the wood.

Keep the chain at proper tension.

Tighten all nuts, bolts and screws except the carburetor adjustment screws after each use.

Warning! In order for the chain brake on your STIHL chainsaw to properly perform its function of reducing the risk of kickback and other injuries, it must be properly maintained. Like an automobile brake, a chainsaw chain brake incurs wear each time it is engaged.

The amount of wear will vary depending upon usage, conditions under which the saw is used and other factors. Excessive wear will reduce the effectiveness of the chain brake and can render it inoperable. For the proper and effective operation of the chain brake the brake band and clutch drum must be kept free of dirt, grease and other foreign matter which may reduce friction of the band on the drum.

For these reasons, each STIHL chainsaw should be returned to trained personnel such as your STIHL servicing dealer for periodic inspection and servicing of the brake system according to the following schedule:

Heavy usage - every three months,
Moderate usage - twice a year,
Occasional usage - annually.

The chainsaw should also be returned immediately for maintenance whenever the brake system cannot be thoroughly cleaned or there is a change in its operating characteristics.

Additionally, the daily maintenance schedule for your chainsaw set forth in your STIHL Owner's Manual should be strictly followed.

Store chainsaw in a dry place and away from children. Before storing for longer than a few days, always empty the fuel tank.

Fuel



Your two-stroke engine requires a mix-ture of brand-name gasoline and quality two-stroke engine oil with the **classification TC**.

Use regular branded unleaded gasoline with a minimum octane number of 90 ROZ (U.S.A./Canada: pump octane min. 89!). If the octane number of the regular grade gasoline in your area is lower use premium unleaded fuel. Fuel with a lower octane number may result in preignition (causing "pinging") which is accompanied by an increase in engine temperature. This, in turn, increases the risk of the piston seizure and damage to the engine.

The chemical composition of the fuel is also important. Some fuel additives not only detrimentally affect elastomers (carburetor diaphragms, oil seals, fuel lines etc.), but magnesium castings as well. This could cause running problems or even damage the engine. For this reason it is essential that you use only name branded fuels!

Use only STIHL two-stroke engine oil or equivalent branded two-stroke air-cooled engine oils with the classification TC for mixing.

We recommend STIHL 50:1 two-stroke engine oil since it is specially formulated for use in STIHL engines. The mix ratio with STIHL oil is 50:1 (50 parts gasoline to 1 part oil), or 25:1 (25 parts gasoline to 1 part oil) with other branded two-stroke air-cooled engine oils.

Do not use BIA or TCW (two-stroke water cooled) mix oils! Take care when handling gasoline. Avoid direct contact with the skin and avoid inhaling fuel vapour.

The canister should be kept tightly closed in order to avoid any moisture getting into the mixture. The fuel tank and the canister in which fuel mix is stored should be cleaned from time to time.

Fuel mix ages:

Only mix sufficient fuel for a few days work, not to exceed 30 days of storage. Store in approved safety fuel-canisters only. When mixing, pour oil into the canister first, and then add gasoline.

Gasoline	STIHL engine oil 50:1	Other branded TC oils 25:1
Liters	Liters (cc)	Liters (cc)
1	0.02 (20)	0.04 (40)
5	0.10 (100)	0.2 (200)
10	0.20 (200)	0.4 (400)
15	0.30 (300)	0.6 (600)
20	0.40 (400)	0.8 (800)
25	0.50 (500)	1.0 (1000)

Gasoline	STIHL engine oil 50:1	Other branded TC oils 25:1
US gal.	US fl.oz	US fl.oz
1	2.6	5.1
2 1/2	6.4	12.8
5	12.8	25.6

Before fueling, clean the filler cap and the area around it to ensure that no dirt falls into the tank.

Always thoroughly shake the mixture in the canister before fueling your machine.

Warning! In order to reduce the risk of burns or other personal injury from escaping gas vapor and fumes, remove the fuel filler cap carefully so as to allow any pressure build-up in the tank to release slowly.

Warning! After fueling, tighten fuel cap **as securely as possible** by hand.

Use a suitable tool (e.g. screwdriver end of combination wrench) to tighten slotted fuel caps.

Change the fuel pick up body every year. Before storing your machine for a long period, drain and clean the fuel tank and run engine until carburetor is dry.

Chain lubricant

Only ecologically acceptable, high-quality chain oil - preferably STIHL chain lubricant with non-filing additive or the rapidly biodegradable STIHL Bioplus - should be used

for automatic, durable lubrication of the saw chain and guide bar.

The quality of the lubricant has a decisive effect on the service life of the saw chain and guide bar. Only special-purpose chain oil should therefore be used!

One of the following HD single-range oils may be used in exceptional cases if a special-purpose chain lubricant is not available.

At outside temperatures of
+ 10 °C. . . + 40 °C SAE 30
+ 10 °C. . . - 10 °C SAE 20
- 10 °C. . . - 30 °C SAE 20W/10W

Waste oil must not be used! Waste oil does not have the required lubricating properties and is unsuitable for chain lubrication.

Waste oil is environmentally harmful and can cause skin cancer as a result of prolonged and repeated contact!

Fill chain lubricant

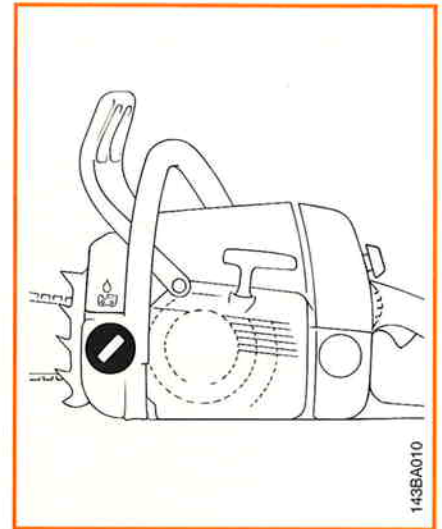

- Thoroughly clean the filler cap and surrounding area so that dirt cannot fall into the tank.
- Fill with chain lubricant - whenever the chainsaw is refuelled.

A small amount of lubricant remains in the oil tank when the fuel tank is empty.

If the amount of lubricant in the oil tank does not decrease, this may be due to a fault in the lubricant supply: check lubrication of the chain, clean the oil ducts and contact the STIHL service centre if necessary.

Mounting the Bar and Chain

Chain brake released

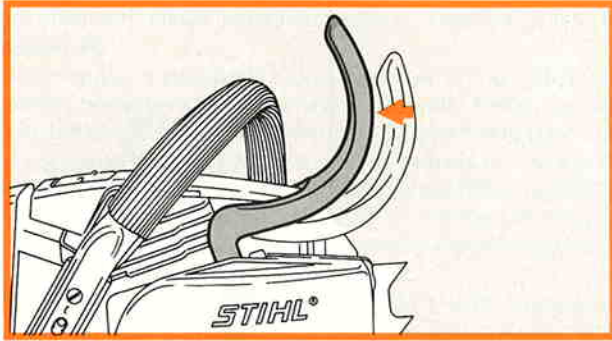

The guide bar and Oilomatic chain are supplied separately. To mount them, first unscrew the hexagon nuts (1) and take off the sprocket cover (2). The chain brake has to be released before this can be done by pulling the hand guard back toward the handlebar.

Now back off the chain tensioning nut (3) by turning the tensioning screw (4) to the left (counterclockwise) to the end of its thread. Hold the guide bar vertically with the nose upwards and fit the Oilomatic chain on it, starting at the bar nose.

The cutting edges of the chain are very sharp. You should always wear gloves to protect your hands from injury when fitting the saw chain, mounting the guide bar, tensioning the saw chain and whenever you check chain tension.

With the chain in position, locate the slot of the guide bar over the studs (5) and place the Oilomatic chain over the sprocket (6) at the same time. Be sure that the cutting edges on the top of the bar face the bar nose. The peg of

Top: Removing chain sprocket cover
Center: Backing off tensioning nut
Bottom: Fitting saw chain on guide bar

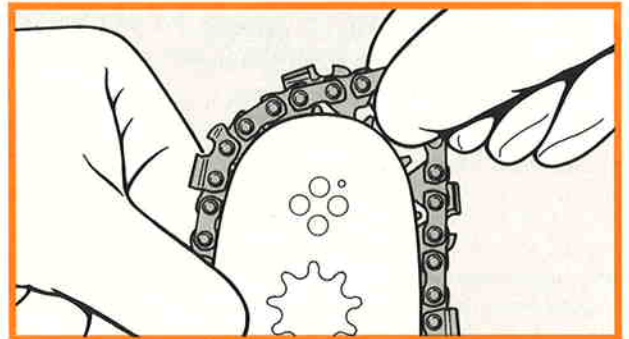
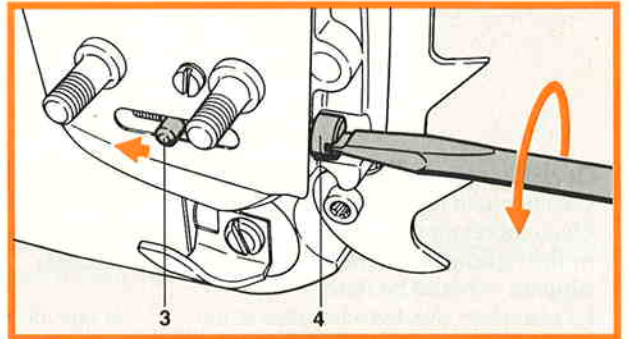
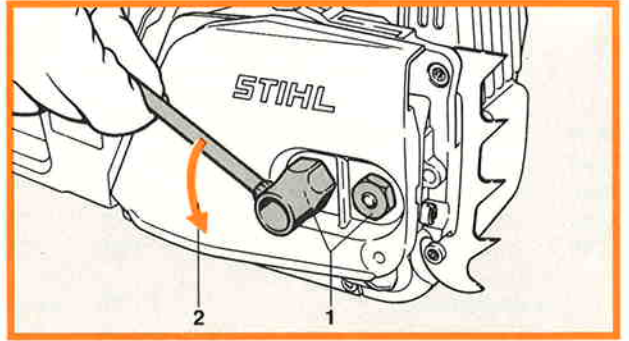

Fitting the chain on the sprocket

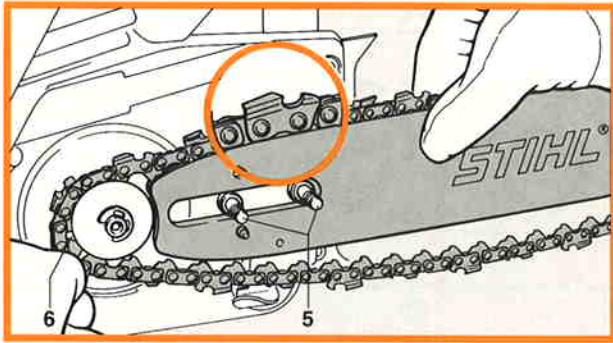

the tensioning nut (3) must engage in the lower guide bar locating hole.

Now tension the chain by turning the tensioning screw (4) clockwise until there is only very little chain sag on the underside of the bar. Make sure that the drive link tangs (7) are properly located in the guide bar groove. Refit the sprocket cover (2) on the studs (5) and screw on the hexagon nuts (1) finger-tight.

Hold the bar nose (8) up and tension the Oilomatic chain until it lies against the underside of the bar. While still holding the bar nose up, tighten down the two hexagon nuts (1) firmly.

The Oilomatic chain is correctly tensioned when it fits snugly against the underside of the bar but can still be pulled easily along the bar by hand. Note that the chain brake must be released for this purpose.

Top: Peg in locating hole – cutting edges point toward bar nose
Center: Drive link tang
Bottom: Tensioning the saw chain

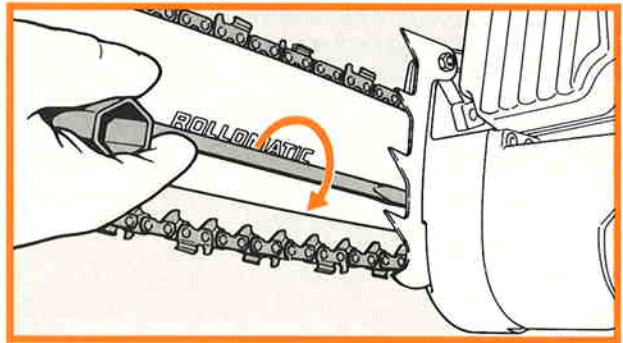
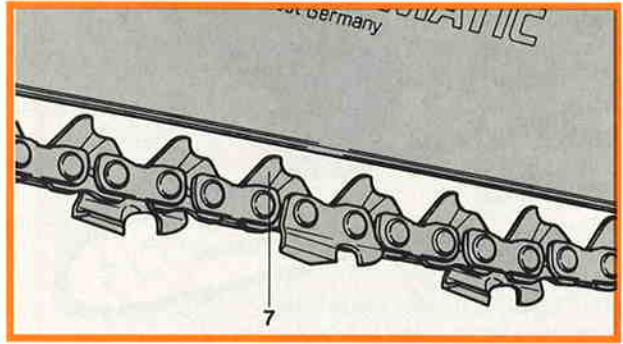
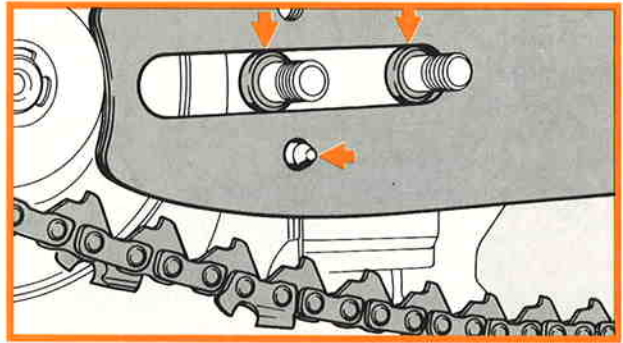

Top: Holding bar nose and tightening one hexagon nut
 Bottom: Checking chain tension

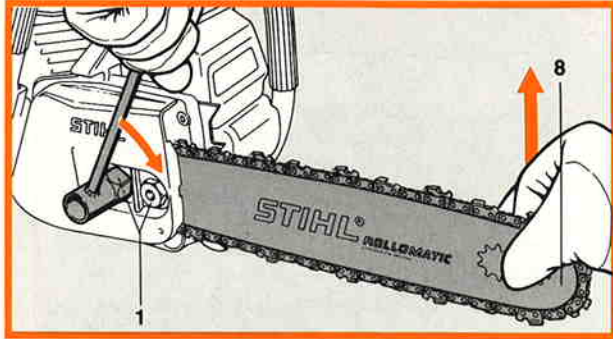

Proper chain tension and lubrication are critically important in respect of cutting performance and the service life of the whole cutting attachment. Always check chain lubrication before starting work. Chain tension should be checked frequently during cutting work and corrected as necessary. For further details see Chapter "Bar, Chain and Sprocket".

Oil Quantity Control

- Ⓐ = Adjusting screw in minimum position
- Ⓑ = Adjusting screw in "E" (Ematic) position
- Ⓒ = Adjusting screw in maximal position

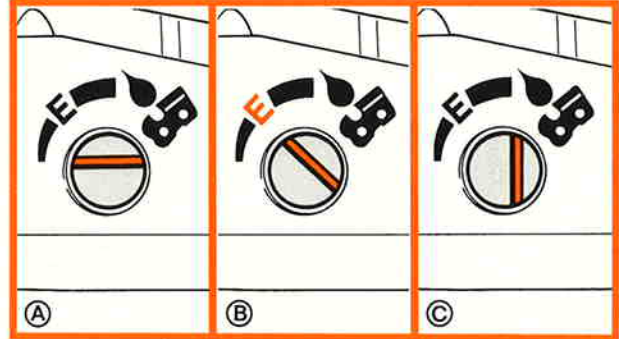

Different quantities of oil are required for different bar lengths, types of wood and cutting techniques to ensure adequate lubrication of the bar and chain. The feed rate of the oil pump can be varied to suit requirements by means of the adjusting screw on the underside of the machine.

The oil feed rate is increased by turning the adjusting screw clockwise or decreased by turning it counter-clockwise.

If you use a STIHL *Ematic* guide bar in normal operating conditions you should leave the adjusting screw in the "E" position. This is the oil pump's most economic setting.

If you fit a shorter guide bar for felling small trees or limbing, you can reduce the oil feed rate to a little less than the "E" position. In case of longer guide bars, large stem diameters and very dry wood it may be necessary to increase the oil feed rate by turning the adjusting screw slightly beyond the "E" position.

Insufficient lubrication can cause an abnormally high rate of wear. For this reason you should make sure the chain is always wetted with a film of lubricant.

Chain Brake

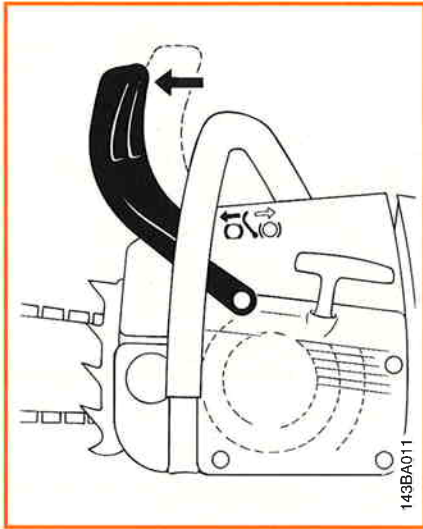

Locking chain with chain brake

- in an emergency
 - when starting
 - at idling speed.
- The chain is stopped and locked when the hand guard is pushed toward the bar nose by the left hand - or when brake is activated by inertia in certain kickback situations.

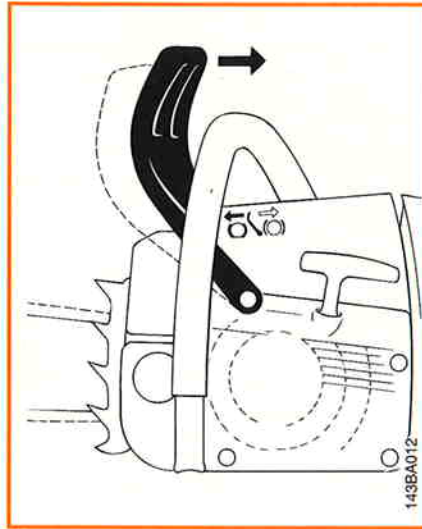

Releasing the chain brake

- Pull the hand guard back toward the front handle.

The chain brake is activated by the inertia of the front hand guard

if the kickback force of the saw is high enough:

The hand guard is accelerated toward the bar nose - even if your left hand is not behind the hand guard, e.g. during felling cut. The chain brake will operate only if the hand guard has not been modified in any way.

Check operation of chain brake

Before starting work: Run engine at idle speed, engage the chain brake (push hand guard toward bar nose). Accelerate up to full throttle for no more than 3 seconds - the chain must not rotate. The hand guard must be free of dirt and move freely.

Chain brake maintenance

The chain brake is subject to normal wear and tear. It must therefore be checked and serviced regularly by trained personnel (e.g. STIHL dealer) at the following intervals:

Full-time professional users:	every 3 months
Semi-professional (farm and construction industry):	every 6 months
Hobby and occasional users:	every 12 months

Notes on Operation

Starting for first time

A factory new machine should not be run at high revs (full throttle off load) for the first three tank fillings. This avoids unnecessary high loads during the break-in period.

As all the moving parts have to bed in during the break-in period, the frictional resistances in the engine are greater during this period. For this reason the engine only develops its maximum power after about 5 to 15 tank fillings. The carburetor setting must never be made leaner in order to achieve an apparent increase in power as this could cause the engine to exceed its maximum permissible rpm (see "Specifications" and "Carburetor").

During operation

After a long period of working at full load it is advisable not to shut off the engine immediately, but let it run for a short while at idling speed. This allows the heat which has been generated in the engine during full throttle operation to be dissipated by the flow of cooling air and also protects engine-mounted components (ignition, carburetor) from thermal overload.

Spark plug

An incorrect carburetor setting, the wrong fuel mix (too much engine oil in the gasoline), a dirty air filter and unfavorable running conditions (mostly at part throttle etc.) affect the condition of the spark plug. These factors cause deposits to form on the insulator nose which may result in trouble in operation.

Top: Spark plug in good condition
Bottom: Spark plug fouled because of incorrect running conditions



If the engine is down on power, difficult to start or runs poorly at idling speed, check the spark plug before looking any further. If the spark plug is dirty, clean it and check the electrode gap. Readjust if necessary; the correct gap is 0.5 mm (0.02 in). The spark plug should be replaced after about 100 operating hours or earlier if the electrodes are badly eroded.

In order to ensure trouble-free operation it is necessary to rectify the faults which have caused fouling of the spark plug.

Master Control

The Master Control lever (1) controls the various engine functions. Depending on its position, it acts on the carburetor's choke valve, the throttle trigger (2) or the ground contact (for stopping the engine).

Note the following when operating the Master Control lever:

The position between "START" and "STOP" is the normal operating position.

The safety throttle lock (3) must be pressed down before the Master Control lever (1) is moved from the normal operating position to "START". It is possible to move from "START" to "CHOKE" or vice versa without touching any other controls.

In the "START" position the choke valve is open and the throttle trigger is in the starting-throttle position. When in this position, the Master Control lever (1) is locked by the throttle lever and must not be forced into the normal operating position. It returns automatically to the normal operating position as soon as the throttle trigger (2) is squeezed.

In the "CHOKE" position (cold start) the choke valve is closed and the throttle trigger is in the starting-throttle position.

In the "STOP" position the ground contact engages the contact spring – this cuts out the ignition system.

- Top: Choke valve activated by Master Control lever (Choke position)
- Center: Master Control lever locked by throttle lever (start position)
- Bottom: Ground contact touching contact spring (stop position)

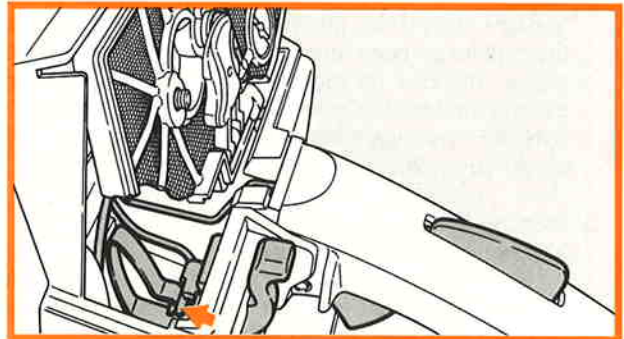
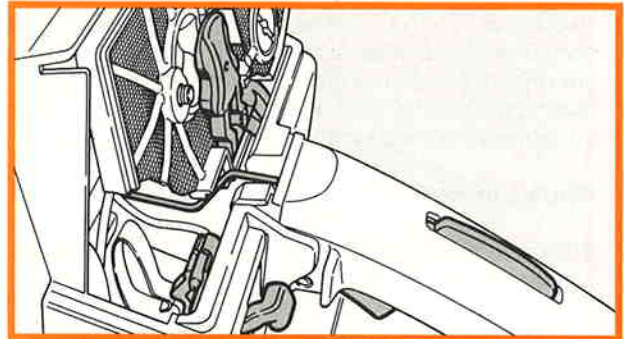
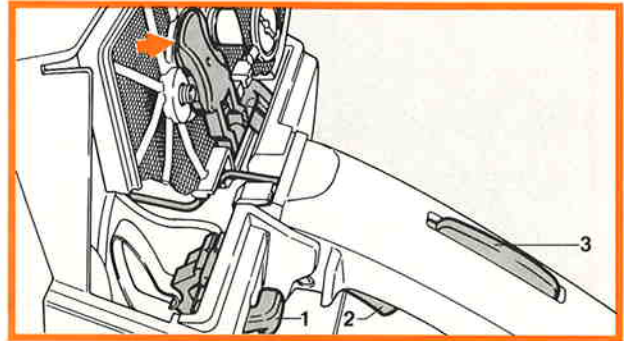

Starting

Chain brake engaged

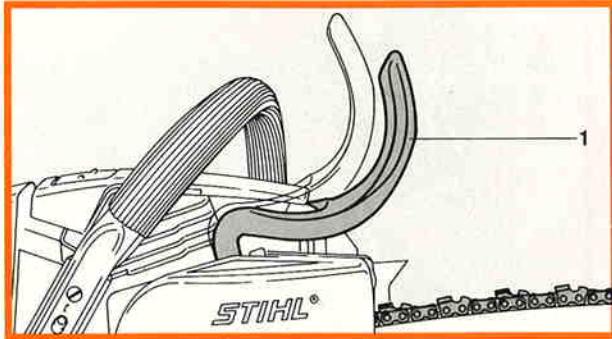

Regardless of the starting method chosen maintain secure footing and be sure that the guide bar and chain are clear of you and all other obstructions and objects, including the ground. Bystanders must be kept well clear of the general work area of the saw.

Starting procedure

1. Engage the chain brake by pushing the hand guard (1) towards the bar nose.
2. If the engine is cold, set Master Control lever (2) to "CHOKE". If the engine has been warmed up, set Master Control lever (2) to "START". This also applies if the engine has been running but is still cold. The throttle trigger interlock (4) must always be engaged before moving the Master Control lever (2) to the "START" or "CHOKE" position. This automatically sets the throttle trigger (3) in the starting-throttle position.

3. Starting the saw

3.1 Starting above the ground

Grip the front handle (5) of the saw with your left hand. Hold the rear handle of the saw tightly between your legs, just above the knees.

Top: Master Control lever on "CHOKE" (cold start)
Center: Master Control lever on "START" (warm start)
Bottom: Starting above the ground

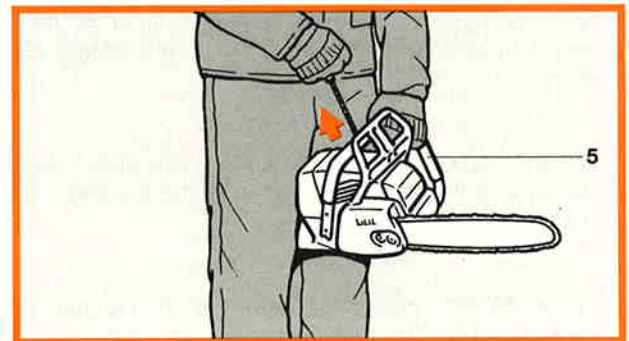
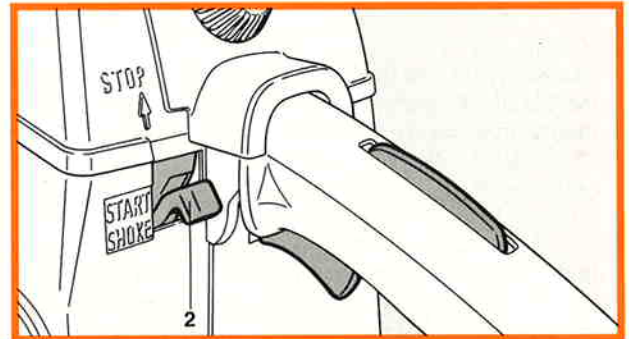
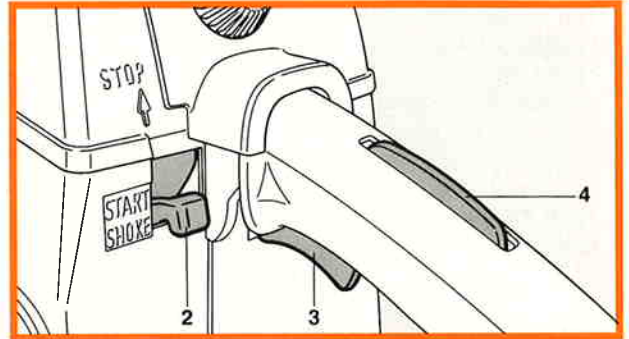

Top: Starting on the ground
Center: Master Control lever in normal operating position –
throttle trigger in idle position
Bottom: Master Control lever on “STOP”

Keep the arm on the front handle in a locked (straight) position.

3.2 Starting on ground level

Hold the saw firmly on the ground with your left hand on the front handle (5), and put your right foot into the rear handle (6) and press down.

4. Pull the starter grip (7) slowly with your right hand until you feel the starter engage, then give the grip a brisk strong pull. The starter rope must not be pulled out more than 70 cm (about 28 in) as it might otherwise break.

Do not let the starter grip (7) snap back. Guide it slowly into the housing so that the starter rope can rewind properly.

5. Crank the engine until it begins to fire. If starting from cold, immediately open the choke (Master Control to “START”) and continue cranking.

As soon as the engine is running, **immediately** squeeze the throttle trigger (3) to disengage it from the starting throttle position. The Master Control lever moves from the start position to its normal operating position and the engine runs at idle speed.

Damage may be caused to the clutch if the engine is not **immediately** returned to idle speed.

6. Disengage the chain brake before starting work by pulling the hand guard (1) back toward the handlebar (5).
7. The engine is stopped by moving the Master Control lever (2) to “STOP”.

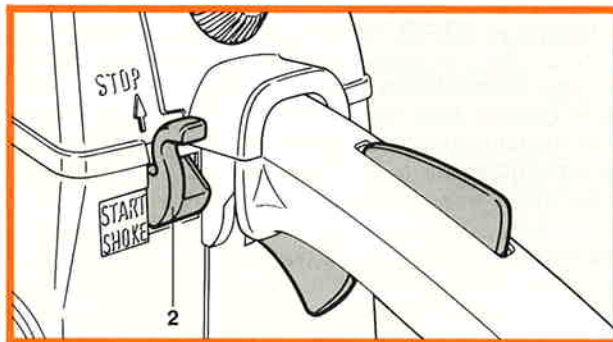
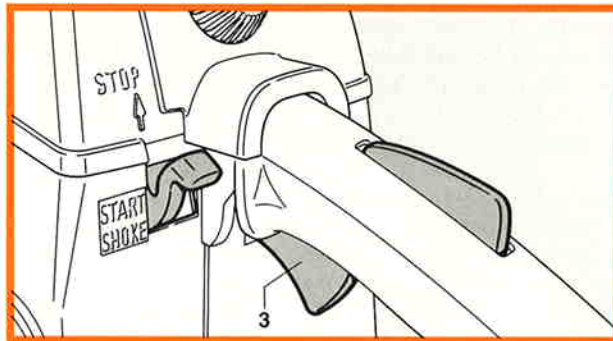

Electrically Heated Handles (Option)

Heating switched on

Caution:

If the Master Control lever is in the "START" position, it must first be disengaged from this position by squeezing the throttle trigger. Only then can the Master Control lever be moved to the "STOP" position.

Other points to observe when starting:

The choke valve is operated by the Master Control lever (see "Master Control").

When starting a cold engine only keep the Master Control lever in the "CHOKE" position until the engine fires. Then move Master Control lever immediately to "START", even if the engine stops and you have continue cranking. If you leave the Master Control lever on "CHOKE", the combustion chamber will flood and stall the engine.

If you have moved the Master Control lever to "START" and the engine still does not run after several attempts, it is already flooded. In such a case, remove and dry off the spark plug. With the spark plug still removed, set the Master Control lever to "STOP" and crank the engine over several times with the starter to clear the combustion chamber. When you now try to start, move the Master Control lever to "START" – even if the engine is cold.

At very low outside temperatures you should still move the Master Control lever to "START" and disengage the throttle trigger from the starting throttle position by briefly accelerating the engine – but then warm up the engine at part throttle for a short period.

A new engine or one which has been run until the fuel tank is dry will not start first time after fueling because fuel will only begin to reach the carburetor after the engine has been cranked over several times.



The handle heating system enables you to keep a warm, comfortable grip on the front and rear handles at extremely low outside temperatures.

The heating system is controlled by means of a switch on the handlebar. The symbols above and below the switch indicate the two switch positions: "O" for heating off – "I" for heating on, i.e. the switch must be moved to "I" to switch the heating on.

The heating system is designed to heat the front and rear handles to an adequate level. There is no risk of overheating during long periods of continuous operation. The whole heating system is maintenance-free.

Intake Air Preheating (Special Accessory)

Plug fitted in shroud



The intake air preheating kit prevents the air filter and carburetor icing up at low outside temperatures as well as the entry of snow into the fan housing.

Carry out the conversion by removing the standard carburetor box cover, taking the plug (1) out of the shroud and fitting it in the cutout in the crankcase (to the right of the flywheel).

When the special carburetor box cover with seal (2) is fitted, the intake air is preheating by the cylinder.

The cover plate (3) is fitted in the fan housing to ensure that no snow can be drawn in through the intake slots.

The standard guard in the sprocket cover can also be exchanged for the smooth contour guard included in the kit to ensure optimum chip discharge even in wet conditions.

Top: Plug fitted in crankcase
Bottom: Special carburetor box cover with seal;
cover plate fitted in fan housing

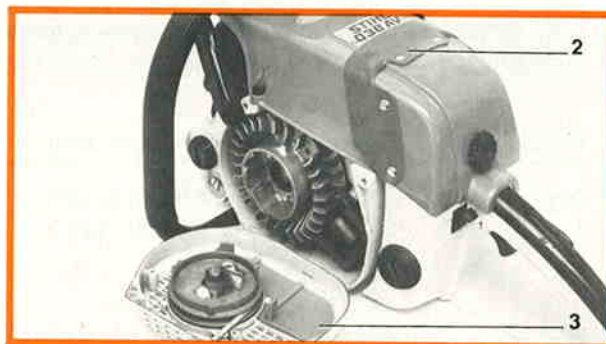

Important: To avoid the risk of engine overheating the conversion to intake air preheating may only be carried out under the following conditions:

Carburetor box cover with seal: below +10°C (+50°F)

Cover plate in fan housing: below -10°C (+14°F)

Detailed instructions for the conversion to intake air preheating are supplied with each kit.

Guide Bar, Chain and Sprocket

Guide bar

The nose and underside of the guide bar are subject to a particularly high rate of wear. To avoid one-sided wear, turn the bar over every time you sharpen or replace the chain. Regular cleaning of the oil inlet holes and guide bar groove is also important. The bar can be examined for signs of wear at the same time.

A minimum bar groove depth must be maintained in order to prevent the drive links contacting the bottom of the groove (the heels of the cutter and tie strap would no longer ride on the guide bar rails). The groove depth varies according to chain type and pitch:

Chain type	Chain pitch	Minimum depth
Rapid	3/8"	6.0 mm (0.24")
Topic	3/8"	6.5 mm (0.26")

The groove depth should be measured at the point where the bar is stressed most. That is the bar nose on Duromatic bars and the area where most of the cutting is done on Rollomatic bars. The guide bar must be replaced when groove depth is less than the specified minimum.

On Rollomatic guide bars it is not necessary to separately lubricate the sprocket nose bearing because the chain oil which flows to the bearing by way of the bar groove during normal operation is adequate for lubrication.

Checking chain lubrication



Breaking in Oilomatic chain

Every new chain has to be broken in for about 2 to 3 minutes. Ample chain lubrication is essential during this period. After breaking in, stop the engine, check chain tension and adjust if necessary.

Chain lubrication

Never operate the chain saw without proper chain lubrication. If the chain is allowed to run dry the whole cutting attachment will be irretrievably damaged within a very short time. For this reason you should always check operation of the chain lubricating system and the level in the oil tank before starting work.

Start the saw and hold the cutting attachment over a light patch of ground. Take care – the Oilomatic chain must not touch the ground; hold it at least 20 cm (8 in) clear of the ground. Run the engine at about half throttle. If an increasing film of oil can be seen on the ground, chain lubrication is operating correctly.

Chain tension

Apart from chain lubrication, chain tension is the factor that has the greatest influence of the cutting attachment's useful life. It is therefore necessary to check chain tension before starting work and at regular short intervals during cutting work. Chain tension is correct in the cold condition when the chain fits snugly against the underside of the bar and can still be pulled along the bar by hand (wear gloves!).

As it warms up to normal operating temperature the chain expands and sags noticeably. The saw chain must be retensioned when the drive links begin to come out of the groove on the underside of the bar. If this is not done, there is a risk of the chain jumping off the bar.

If the chain is retensioned during cutting work it must always be slackened off again after finishing work. This is necessary because high contraction stresses would otherwise occur as the chain cools down to ambient temperature, especially at extremely low outside temperatures, and cause damage to the crankshaft and bearings.

A new chain must be retensioned more frequently than a used one because it stretches during the initial break-in period.

Chain sprocket

The stress and strain on the chain sprocket are particularly high. If the wear marks on the teeth are very pronounced (about 0.5 mm/0.02 in deep), the sprocket should be replaced. A worn sprocket reduces the service life of the

Worn chain sprocket



saw chain. The chain sprocket should be replaced as a matter of routine with every second Oilomatic chain. It is best to use saw chains alternately with one sprocket.

Air Filter

The air filter's function is to intercept dust and dirt in the intake air and thus reduce wear on engine components.

A clogged air filter has a detrimental effect on engine performance, it increases fuel consumption and makes starting more difficult.

The air filter must be cleaned when there is a noticeable loss of engine power.

The carburetor box cover is removed by turning the twist lock to the left (counterclockwise). Clean exterior of air filter and area around it and then use a screwdriver to unscrew the two slotted nuts. The two-part air filter assembly can now be pulled off the studs. Prise apart the two halves of the filter with a screwdriver.

For the daily cleaning it will do, if both filter parts and the prefilter in the carburetor box cover are cleaned with a natural bristle paint brush.

To clean the element, first knock it out on the palm of your hand and then wash it in non-flammable cleaning solution (lukewarm soapy water, engine cleaner etc.) and blow out with compressed air if possible.

If the wire mesh is damaged on either half of the air filter (or if the flocking is damaged), always fit a new part.

Re-install the air filter in the reverse sequence described above, making sure that the choke mechanism is not damaged.

We recommend that you have a spare filter available. A badly plugged filter should be serviced by your local dealer.

Top: Releasing slotted nut
Center: Prising apart the two halves of the filter
Bottom: Air filter with choke valve in position

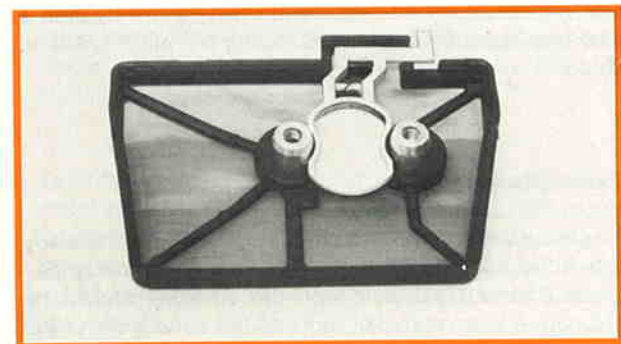
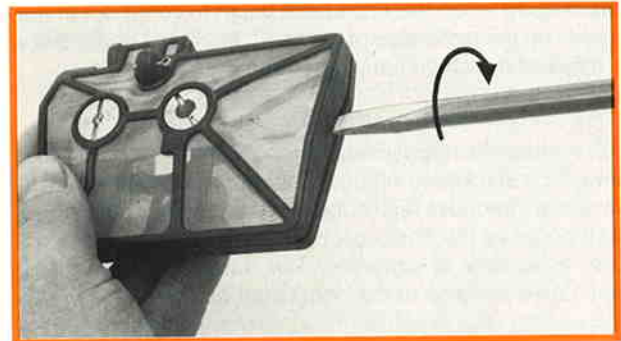
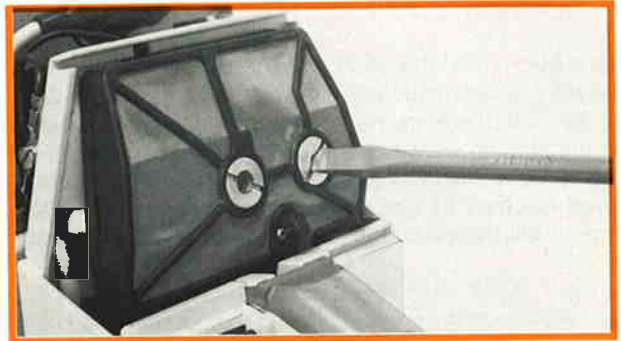

Carburetor

- 1 = High speed adjusting screw
- 2 = Low speed adjusting screw
- 3 = Idle speed adjusting screw

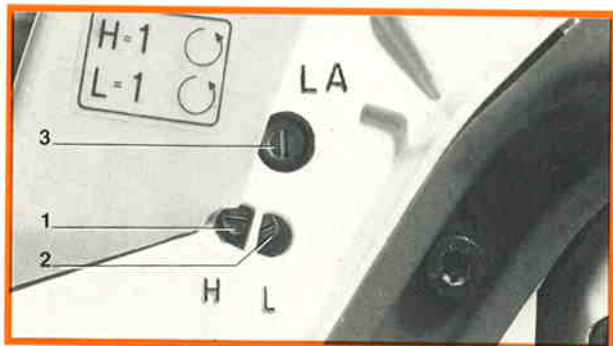

The carburetor has been adjusted for optimum performance under the barometric pressure and climatic conditions at the factory (300 m/1000 ft above sea level). If the conditions at your operating site are different, it may be necessary to change the carburetor setting to achieve maximum engine power.

Make the correction with adjusting screws 1 and 2 (1 for full load and 2 for idle). Turn screws clockwise (leaner) for high altitude operation or counterclockwise (richer) for operation at sea level.

Note that even slight alterations on the adjusting screws have a noticeable effect on the engine's running behavior. Only carry out carburetor adjustments after cleaning the air filter and warming up the engine.

Caution: The setting of the high speed adjusting screw not only affects power output but also the maximum off-load engine speed. If the setting is too lean (screw turned too far clockwise), the maximum permissible engine speed will be exceeded. This can cause engine damage,

Regulating idle speed adjusting screw

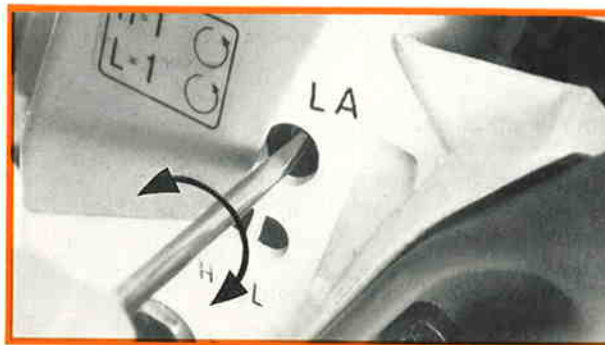

brought about by lack of lubrication and overheating in particular. Corrections to the setting of the high speed adjusting screw may be carried out only if an accurate tachometer is available to check the maximum engine speed of 12,500 r.p.m. (with bar and correctly tensioned chain).

Basic setting

If it is necessary to readjust the carburetor again from the beginning, first carry out the basic setting to obtain a starting point for fine adjustment. To do this, carefully screw the two adjusting screws down onto their seats (clockwise). Then make the following adjustment:

- High speed adjusting screw H:** back off 1 complete turn
- Low speed adjusting screw L:** back off 1 complete turn

If you have no means of checking the maximum engine speed, do not set the high speed adjusting screw any leaner by turning it beyond the basic setting.

Notes for adjusting idle speed

Engine stops while idling

Turn idle speed adjusting screw (LA) clockwise until chain begins to run. Then back off one quarter of a turn.

Chain runs when engine is idling

Turn idle speed adjusting screw (LA) counterclockwise until chain stops running and then turn it about another quarter turn in the same direction.

Erratic idling behavior; poor acceleration

Idle setting too lean; turn low speed adjusting screw (L) counterclockwise until engine runs and accelerates smoothly.

Exhaust smokes at idle speed

Idle speed setting too rich; turn low speed adjusting screw (L) clockwise until engine speed drops. Then turn screw back one quarter turn and check that engine still accelerates smoothly when you open the throttle.

A correction at the low speed adjusting screw usually necessitates a change in the setting of the idle speed adjusting screw (LA).

Apart from minor readjustments, you should leave all carburetor setting and repair work to your STIHL dealer. STIHL dealers have trained staff and all the necessary servicing tools and equipment.

Replacing the Chain Sprocket

Removing the side plate

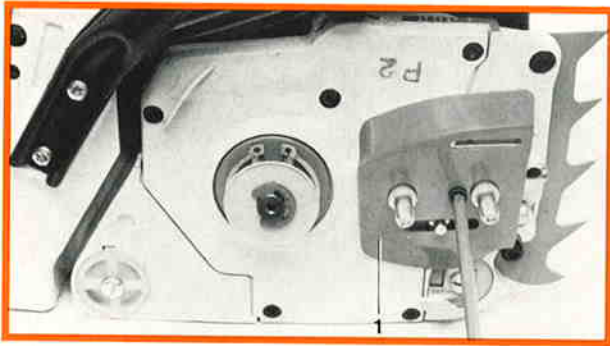

Top: Unscrewing the cover
Center: Removing E-clip
Bottom: Removing circlip

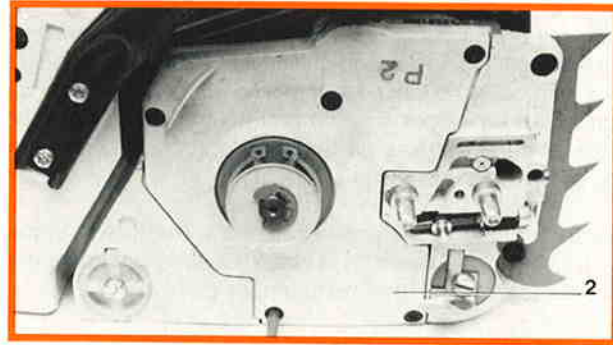

Spur sprocket

First disengage the chain brake by pulling the hand guard back against the handlebar.

Now remove the chain sprocket cover, Oilomatic chain and guide bar. Release and unscrew the six pan head screws which hold the side plate (1) and cover (2).

Insert a pointed knife or similar tool behind the E-clip (3) to ease it clear of the warts on the thrust washer (4) and then use a small screwdriver to prise the E-clip off the crankshaft.

Pull off the thrust washer and use circlip pliers 5910 893 1805 (special accessory available from your STIHL dealer) to take the circlip (5) off the chain sprocket.

The washer (6) can now be removed from the chain sprocket. Removal of this washer (6) is made easier if you hold the chain sprocket (7) steady and prise the cover (2) slightly away from the crankcase. Then take off the cover as well.

Only original STIHL chain sprockets may be installed.

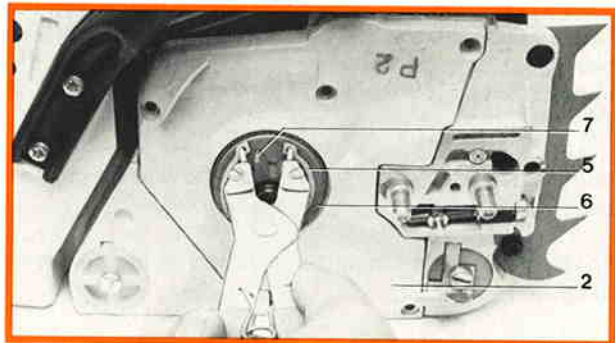
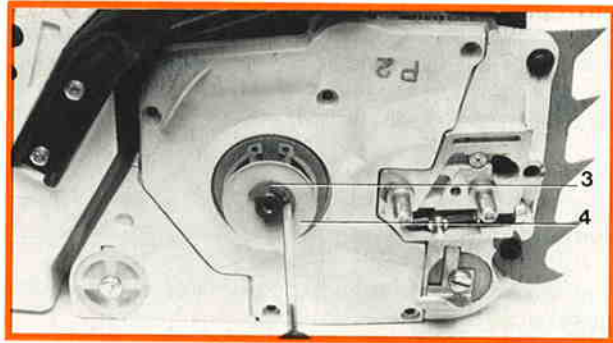

Remove the oil pump drive worm (8) from the pump shaft by turning it clockwise and pulling it at the same time. The chain sprocket (7) can now be pulled off the crankshaft together with the spur gear (9) and needle cage. The spur gear (9) can be prised off the chain sprocket (7) with the aid of two screwdrivers.

Clean the stub of the crankshaft, wash the needle cage, spur gear (9) and worm (8) in clean gasoline. Lubricate the needle cage with STIHL multipurpose grease.

Reverse the above sequence for reassembly. Examine spur gear (9) and worm (8) for worn or broken teeth and replace if necessary. Coat the teeth of the spur gear and worm with STIHL multipurpose grease when installing. The circlip (5) must be fitted so that both its ends locate on the top of a tooth as illustrated.

Rim sprocket

First remove the chain sprocket cover, Oilomatic chain and guide bar.

Insert a pointed knife or similar tool behind the E-clip (3) to ease it clear of the warts on the thrust washer (10) and then use a small screwdriver to prise the E-clip off the crankshaft. Take off the thrust washer and rim sprocket (11).

Fit the new rim sprocket so that the side with the cavities faces outward.

Finish off by refitting the thrust washer (10) and E-clip (3) on the crankshaft.

40 Only original STIHL clutch drums may be installed.

Top: Removing the drive worm
Center: Circlip correctly fitted
Bottom: Rim sprocket in position

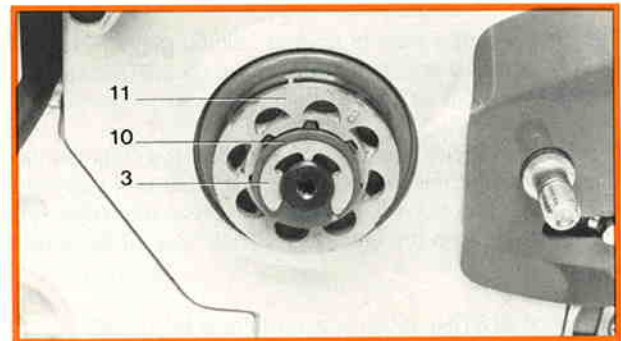
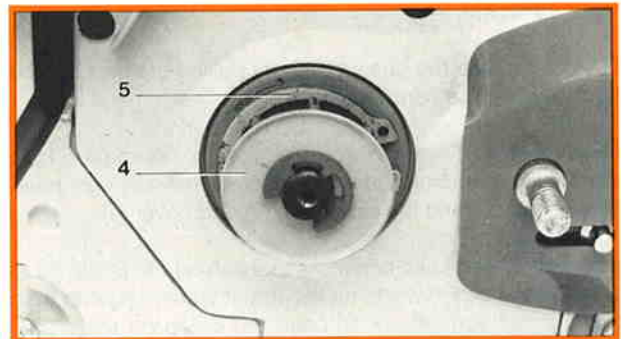
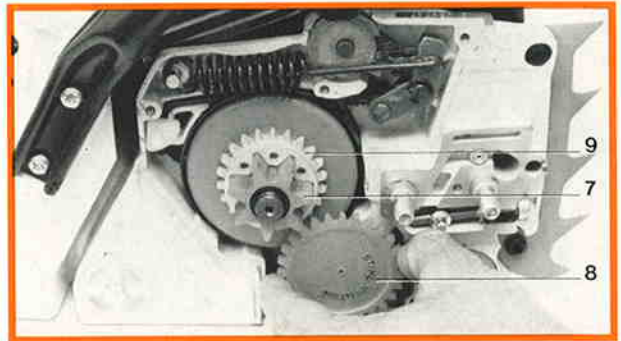

Starter Assembly

Remove the mounting screws



Top: Possible special knots
Bottom: Component parts of the starter assembly

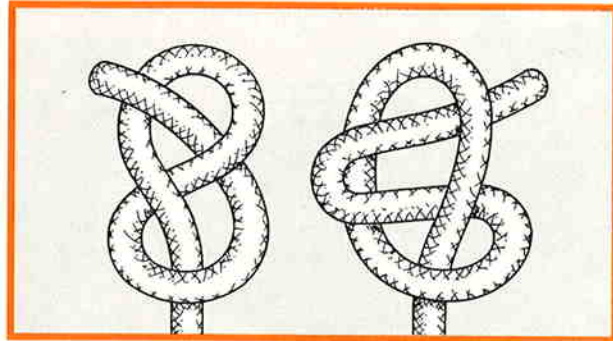

Replacing a broken starter rope

First remove the three screws which retain the fan housing. Next lift the base of the fan shroud away from the crankcase and slide downward and away from the engine.

Using a screwdriver, or a suitable pair of pliers, carefully remove the spring clip from the starter post groove. The rope rotor, together with the pawl can now be lifted off.

Remove any remaining rope from the rope groove in the rotor. Thread in a new starter rope, 4.5 mm (0.18 in) diameter and 1000 mm (40 in) long and secure it to the rope rotor with a simple overhand knot. Seal the ends of the rope to prevent ravelling with a match or lighter flame. Thread the other end of the rope through the rope guide hole in the fan housing from inside, pass it through the starter grip in an upward direction and secure it with a figure 8 or looped overhand knot (see diagram of knots).

Do not rewind the rope on the rotor at this time.

Clean and lubricate the rope rotor's bushing with a non-resinous oil, slide the rotor on the starter axle or post and align the rewind spring anchor loop (exposed through the

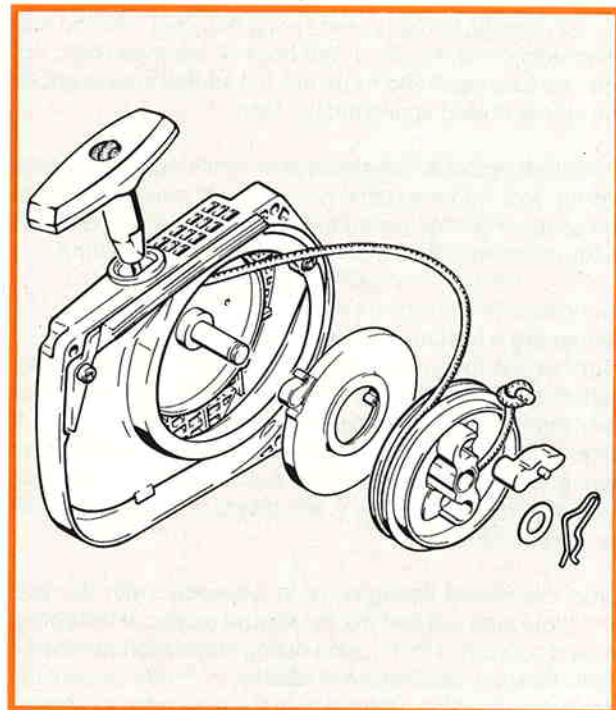

Installing the spring clip



center opening in the rewind spring housing) with the notched section of the rib on the back of the rope rotor. Rotate the rotor back and forth until the slotted area engages the starter rewind spring anchor loop.

Now insert pawl in rope rotor and press spring clip onto starter post with a suitable pair of pliers, making sure that the spring clip engages on the pawl's guide bin and points in the clockwise direction. Then tension rewind spring.

Replacing a broken rewind spring

Remove the rope rotor as above. The spring housing together with the rewind spring can then be removed from the fan housing by turning the fan housing over and let it drop out of the recess in the fan housing. A replacement spring and spring housing are supplied as an assembly. Lubricate the spring with a few drops of non-resinous oil before installing it.

Drop the rewind spring/housing assembly (with the bottom plate area up) into the fan shroud recess. If the spring should pop out of its housing during installation re-insert it in its housing starting from outside to inside in counter-clockwise direction. Reassemble the rope rotor as above.

Tensioning the rewind spring



Tensioning the rewind spring

With the starter rope fully extended, make a loop in the rope between the rotor and fan housing and use it to turn the rope rotor six full revolutions clockwise. Hold the rope rotor steady in this position. Pull out and straighten the twisted rope. Now release the rope rotor gradually and allow spring force to wind the starter rope fully onto the rope rotor.

The rewind spring is tensioned correctly if the starter grip is held firmly in place against the starter housing by spring tension and does not droop. If more tension is required add one more turn on the rope rotor. The rope rotor should be able to be rotated by at least one-half an extra turn with the rope pulled all the way out. If spring tension is too great pull out the starter rope, hold the rotor firmly by hand, and remove one turn of the rope.

A starter spring that is tensioned too heavily will probably break.

Re-install the fan shroud with the retaining screws securely tightened.

Maintaining and Sharpening Saw Chain

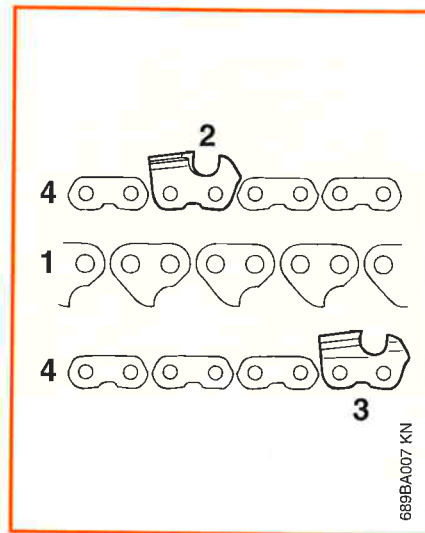

Correctly sharpened chain

A properly sharpened chain slices through wood effortlessly and requires very little feed pressure.

Do not work with a dull or damaged chain as it will increase the physical effort required, produce unsatisfactory results and a higher rate of wear.

Clean and check your chain

for cracks in the links and damaged rivets -

replace any damaged or worn parts of the chain and match the new parts to the shape and size of the original parts.

- The illustration shows
- 1 drive links
 - 2 left-hand cutter
 - 3 right-hand cutter
 - 4 tie straps.

Replacing individual parts of chain

Use the following tools:
STIHL NG 4 chain breaker*
STIHL NG 5 rivet spinner*
STIHL NG 6 chain breaker and rivet spinner*

Instructions for use are supplied with the tools.

*Special accessory

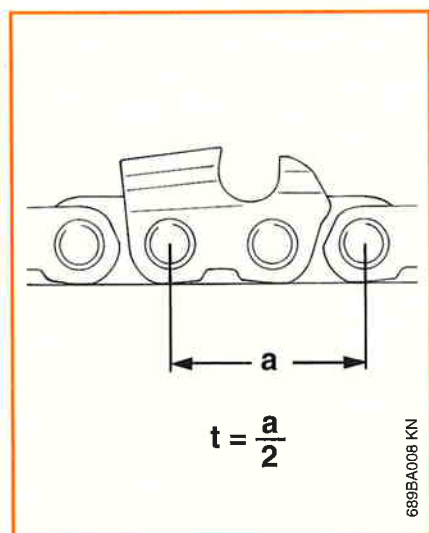

Select sharpening tools to suit chain pitch

You can use chains with the following pitches (t) on your saw:

- t = 0.325" = 8.25 mm
- t = 3/8" = 9.32 mm

Chain pitch must match chain sprocket and drive link gauge must match guide bar.

Check as follows: Chain pitch
t = distance from one rivet to the next rivet but one, divided by two.

Use only special saw chain files

Other files have the wrong shape and cut.

Select file diameter according to chain pitch.

Chain pitch	File-dia.	Part No.
Inch (mm)	mm (Inch)	
0.325 (8,25)	4,8 (3/16)	0811 412 8088
3/8 (9,32)	5,2 (13/64)	0814 243 3384

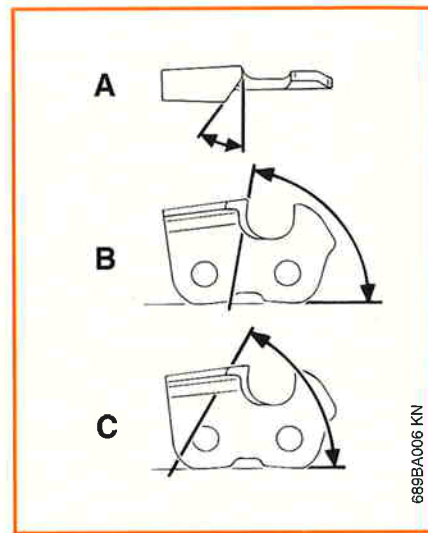

You must observe certain angles when sharpening the chain cutters

- A** = Filing angle
- B** = Side plate angle
- C** = Top plate cutting angle:

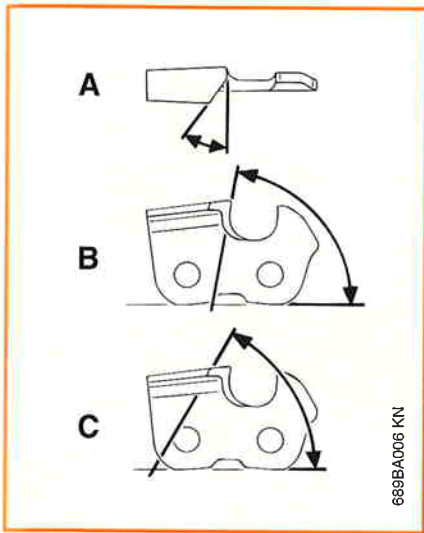

Chain type	Angle (°)		
	A	B	C
Rapid-Micro (RM)	30	85	*
Rapid-Super (RS)	30	60	*

* This angle is difficult to measure because the top plate cutting edge is very short. It is obtained automatically if the filing and side plate angles are maintained as specified.

Cutter shapes:

- Micro = Semi-chisel
- Super = Full chisel

Specified angles A, B, and C are obtained automatically if recommended files or sharpening tools and correct settings are used.

Furthermore, the angles must be the same on all cutters.
If angles are uneven:
Chain will run roughly, not in a straight line, wear quickly and finally break.

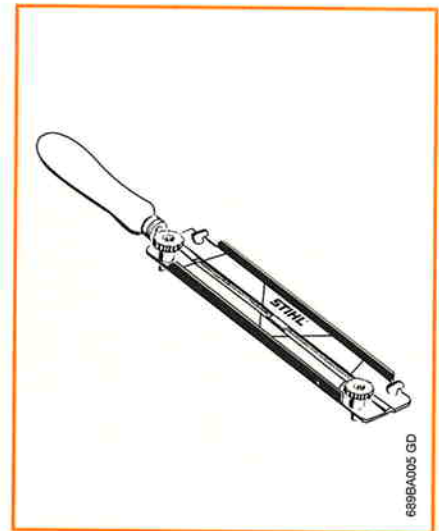

As these requirements can be met only after sufficient and constant practice:

Use a file holder.

A file holder must be used for manual resharpening of Super chain. The correct filing angle is marked on the file holder.

Chain pitch Inch (mm)	File holder Part No.
0.325 (8.25)	5605 750 4328
3/8 (9.32)	5605 750 4329

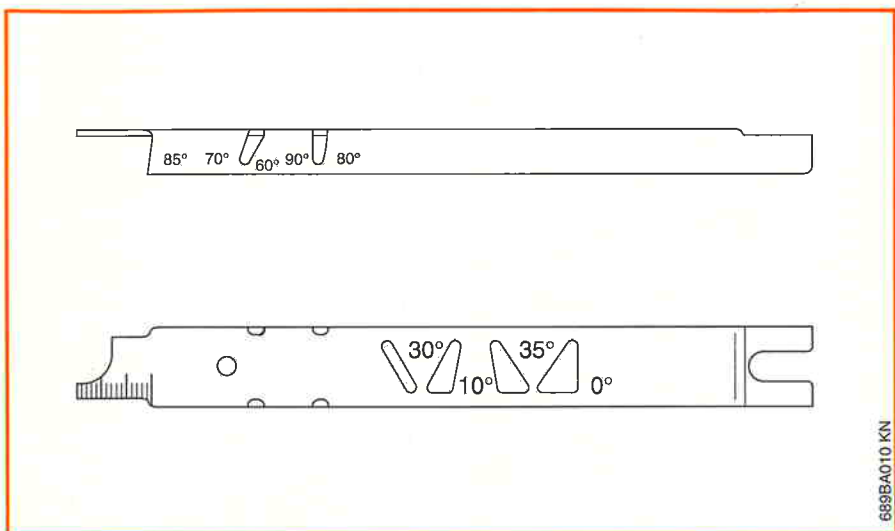

Other filing and sharpening aids
for all types of chain:

FG 1 filing tool* -
attaches to guide bar
Part No. 5603 000 7500

FG 2 Filerite* -
mounts to workbench
Part No. 5604 000 7501

USG electric grinder*
Part No. 5203 201 0403

Operating instructions are supplied with
all tools.

For checking angles
STIHL filing gauge*
Part No. 1110 893 4000

A universal tool for checking the filing
and side plate angles, depth gauge
setting and cutter length. Also cleans the
guide bar groove and oil inlet hole.

For lowering depth gauges

Triangular file*
Part No. 0811 421 8971

Flat file*
Part No. 0814 252 3356

* Special accessory

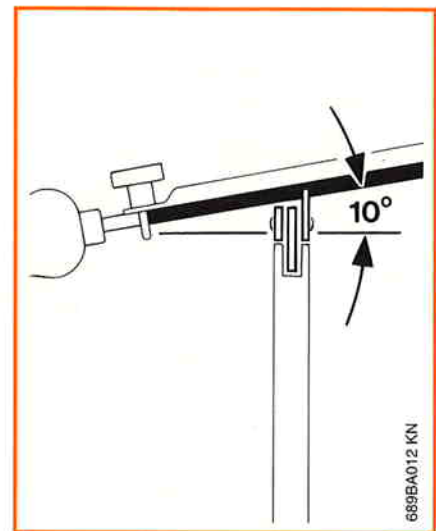
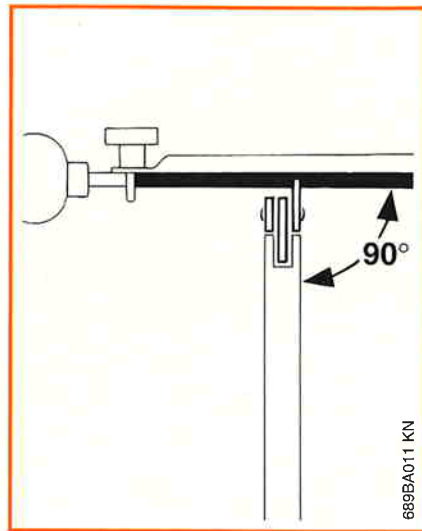
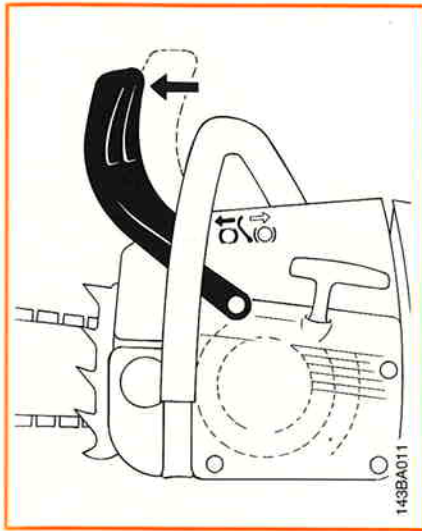

File correctly

- If you use the FG 2 or USG: Remove the chain from the bar and sharpen according to instructions supplied with the tool.
 - If you use a file holder or the FG 1: Leave the chain on the bar.
 - Clamp the bar in a vise if necessary.
 - Lock the chain - push hand guard forward
 - To rotate the chain - pull hand guard against front handle
 - Sharpen chain frequently, take away as little metal as possible - two or three strokes of the file are usually enough
 - Always file from the inside to the outside of the cutter.
- The file only sharpens on the forward stroke - lift the file off the cutter on the back-stroke.
 - Hold the file **horizontally** for all chain types (at right angle to side of guide bar) and file according to the angles marked on the filing tool.
- If you use **Super chains in hardwood or frozen timber**, hold file so that it slopes upward at **10°** - for a longer edge life and smoother cutting action.
 - Avoid touching the tie straps and drive links with the file.
 - Rotate the file at regular intervals while filing - this avoids one-sided wear.
 - Use a piece of hardwood to remove burrs from cutting edge.
 - Check angles with the filing gauge.

All cutters must be the same length

If the cutters are not the same length, they will have different heights. This makes the chain run roughly and can cause it to break.

Find the shortest cutter and then file all other cutters back to the same length. This can be very time consuming - it is best to have it done in the workshop on an electric grinder.

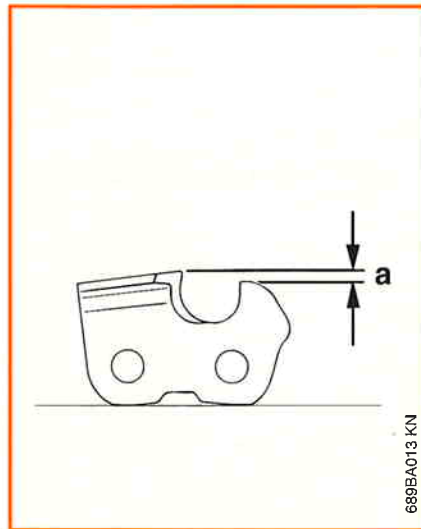

Depth gauge setting

The depth gauge determines the height at which the cutter enters the wood and thus the thickness of the chip removed.

Distance between depth gauge and cutting edge = **a**:
a = 0.65 mm (0.025") on 0.325" and 3/8"

This setting may be increased by 0.2 mm (0.008") for cutting softwood in mild weather season - no frost.

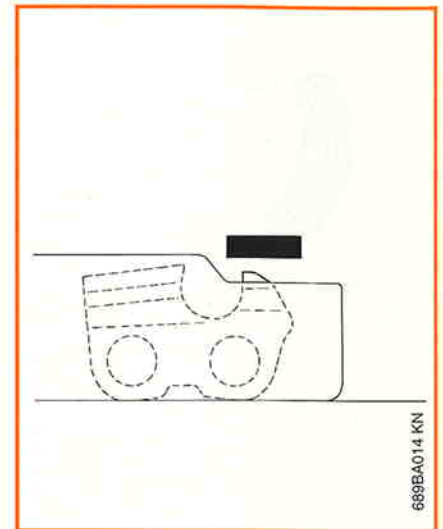

Lowering depth gauges

The depth gauge setting is reduced when the chain is sharpened. Use filing gauge to check the setting every time you sharpen the chain and, if necessary, lower the depth gauge with a flat or triangular file so that it is level with the filing gauge.

Filing gauge for depth gauge setting of 0.65 mm:
Part No. 1110 893 4000

Round off depth gauges parallel to the stamped marking.

Storing the machine

After sharpening

Clean the chain thoroughly, remove filings or grinding dust - lubricate the chain by immersing it in an oil bath.

Before long out-of-service period

Clean the chain with a brush and immerse it in an oil bath.

Please quote the following details when ordering a new chain:

Chain type, e.g. Rapid-Super,
Chain pitch, e.g. 3/8"
Number of drive links, e.g. 72
Bar length, e.g. 50 cm (20")

For periods of about 3 months or longer:

- Drain and clean the fuel tank.
- Run engine until carburetor is dry - this helps prevent the carburetor diaphragms sticking together.
- Remove the saw chain and guide bar, clean them and protect with corrosion inhibiting oil.
- Thoroughly clean the machine - pay special attention to the cylinder fins and air filter.
- If you use Bioplus, fill the chain oil tank.
- Store the machine in a dry, high or locked location - out of the reach of children and other unauthorized persons.

Maintenance Chart

Please note that the following maintenance intervals apply for normal operating conditions only. If your daily working time is longer than normal or cutting conditions are difficult (very dusty work area tropical wood etc.) shorten the specified intervals accordingly.

		before starting work	after finishing work or daily	after each refueling stop	weekly	monthly	if faulty	if damaged	as required	see page:
Complete machine	Visual inspection (condition, leaks)	X		X						
	Clean		X							
Throttle trigger , throttle trigger interlock, Master Control, depending on model	Check operation	X		X						
Chain brake	Check operation	X		X						27
	Clean by STIHL dealer								X	
Filter in fuel tank	Check					X				
	Clean, Replace filter element							X		
Fuel tank	Clean					X				
Chain oil tank	Clean					X				
Chain lubrication	Check	X								34, 35
Saw chain	Inspect, also check sharpness	X		X						
	Check chain tension	X		X						35
	Sharpen								X	45
Guide bar	Check (wear, damage)	X								34
	Clean and turn over				X		X			
	Deburr				X					
Chain sprocket	Replace							X	X	
	Check				X					35
Air filter	Clean	X					X			36
	Replace							X		36
Cooling inlets	Clean		X							
Cylinder fins	Clean					X				
Carburetor	Check idle adjustment – chain must not turn	X		X						37
	Readjust idle								X	37
Spark plug	Readjust electrode gap						X			
All accessible screws and nuts (not adjusting screws)*	Retighten								X	
Rubber vibration buffers	Inspect				X					
	Have replaced by STIHL dealer							X		
Muffler	Inspect					X				
	Inspect spark arrestor screen	X								
Chain catcher	Clean or replace spark arrestor screen							X		
	Check	X								
	Replace							X		

Specifications

Engine

STIHL single cylinder two-stroke engine

038 S

Displacement: 66.8 cm³(4.07 cu.in)
Bore: 50 mm (1.97 in)
Stroke: 34 mm (1.34 in)
Power: 3.3 kW
Maximum engine speed with cutting attachment: 13.500 r.p.m.
Idle speed: 2500 r.p.m.

Magnum

Displacement: 72.2 cm³(4.4 cu.in)
Bore: 52 mm (2.04 in)
Stroke: 34 mm (1.34 in)
Power: 3.6 kW
Maximum engine speed with cutting attachment: 13.500 r.p.m.
Idle speed: 2500 r.p.m.

For Europe only

Sound pressure level L_{peq}
according to ISO 7182¹⁾ 102 dB (A)

Sound power level L_{weq}
according to ISO 9207¹⁾ 113 dB (A)

Vibration measurement a_{eq}
according to ISO 7505¹⁾

left handle 4,0 m/s²
right handle 5,6 m/s²

¹⁾ Weighted equivalent level includes idling, full load and racing with the same duration of exposure

Ignition System

Type:
Electronic magneto ignition (breakerless)

Spark plug (suppressed):
Bosch WSR 6 F or NGK BPMPR 7 A;
Heat range 200
Electrode gap 0.5 mm (0.02 in)
Spark plug thread M 14x1.25,
9.5 mm (0.37 in) long

For Canada only:

This spark ignition system meets all requirements of the Canadian Interference-Causing Equipment Regulations.

Fuel System

Carburetor:
All position diaphragm carburetor with integral fuel pump

Air filter:
Flat, two-part wire mesh filter

Fuel tank capacity:
0.68 l (1.43 US pt)

Fuel mixture: see chapter "Fuel"

Cutting Attachment

Guide bars:
Rollomatic with sprocket nose
Duromatic with stellite tipped nose

Bar lengths:
Rollomatic 37, 40, 45 and 50 cm
(14.5, 16, 18 and 20 in)
Duromatic 40, 45 and 50 cm
(16, 18 and 20 in)

Oilomatic chains:
Standard:
3/8" (9.32 mm) Rapid-Micro, -Rapid-Super, -Topic-Micro, -Topic-Super
Drive link gauge: 1.6 mm (0.063 in)

Chain sprockets:
Standard
7-tooth for (3/8") pitch

Chain lubrication:
Fully automatic oil pump.

Oil tank capacity:
0.36 l (0.76 US pt)

Weight

without bar and chain

038 AVESQFB: 6.6 kg (14.6 lb)
038 AVSEQ: 6.6 kg (14.6 lb)
038 AVMEQ: 6.6 kg (14.6 lb)

For Canada only:

STIHL cutting attachments complying
with CSA Standard CAN 3-Z 62.3:

Guide bar:
STIHL Rollomatic
with sprocket nose (11 tooth)
40, 45, 50 cm (16, 18, 20 in)

Saw chain:
STIHL chain 33 RS, 33 RM, 33 RM2
9.32 (3/8")

Other cutting attachments complying
with CSA Standard CAN 3-Z 62.3
are available (see "Chain Leaflet" inside
chain box or contact your local STIHL
dealer).

Please ask your STIHL dealer to
properly match your powerhead with the
appropriate bar/chain combinations
to reduce the risk of kickback injury.

Ordering Spare Parts

Please enter your saw model, machine number as well as the part numbers of the guide bar, saw chain and chain sprocket in the spaces provided on the right

This will make re-ordering simpler.

The guide bar, saw chain and chain sprocket are subject to normal wear and tear.

The part numbers of the standard bar, chain and sprocket are printed on the right for your convenience.

When purchasing these parts, always quote the saw model, the part numbers and names of the parts.

Model

--	--	--	--	--	--	--	--	--	--	--	--	--	--	--	--	--	--	--	--	--

Machine number

--	--	--	--	--	--	--	--	--	--	--	--	--	--	--	--	--	--	--	--	--

Guide bar part number

--	--	--	--	--	--	--	--	--	--	--	--	--	--	--	--	--	--	--	--	--

Chain part number

--	--	--	--	--	--	--	--	--	--	--	--	--	--	--	--	--	--	--	--	--

Sprocket part number

--	--	--	--	--	--	--	--	--	--	--	--	--	--	--	--	--	--	--	--	--

Standard equipment

Rollomatic bar 40 cm (16 in) (not for Canada)	3003 000 6113
3/8" Rapid-Micro Spur sprocket 7-tooth 3/8"	3859 000 0060
Rim sprocket 7-tooth 3/8"	1119 640 2000
	0000 642 1223

Warranty claims following repairs can be accepted only if the repair has been performed by an authorized STIHL Service Shop using original STIHL spare parts.

Original STIHL parts can be identified by the STIHL part number, the logo **STIHL** and the STIHL parts symbol 

The symbol may appear alone on small parts.

Certificate of conformity

This Certificate of Conformity applies only in the countries of the European Union.

Certificate of conformity
(Clause 8 of Directive 89/392/EEC)

I, the undersigned

Andreas Stihl
Badstr. 115
D-71336 Waiblingen

certify that the new machine described below

Category: Chain saw
Make: STIHL
Model: 038
Serial identification: 1119

conforms to the specifications of Directive 89/392/EEC and 89/336/EEC.
The product has been developed and manufactured in compliance with the following standard: EN 608, EN 50082, CISPR 12

"The CE type examination was carried out by"

CTBA
10, avenue de Saint-Mande
F-75012 Paris

Ex. number (038 M): 380-080-A-0032-01-95

Done at Waiblingen,
January 1996

ANDREAS STIHL



Glöckle
Director Engineering Services and Product Research

54

Quality Certification



All STIHL products comply with the highest quality standards.

An independent organization has certified that all products manufactured by STIHL meet the strict requirements of the ISO 9001 standard for quality management systems in terms of product development, materials purchasing, production, assembly, documentation and customer service.





For Canada only:

Important Safety Precautions



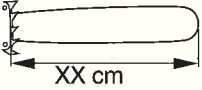

1. Fatigue causes carelessness. Be more cautious before rest periods and before the end of your shift.
2. Safety clothing required by your safety organizations, government regulations, or your employer should be used; otherwise, snug fitting clothing, safety foot-wear, and hand and hear protection should be worn.
3. Before fuelling, servicing, or transporting your chain saw, switch off the engine. To help prevent fire, restart your chain saw at least 3 m (10 ft) from the fuelling area.
4. When using a chain saw, a fire extinguisher should be available.
5. When felling, keep at least 2 1/2 tree lengths between yourself and your fellow workers.
6. Plan your work, assure yourself of an obstacle-free work area and, in the case of felling, of an escape path from the falling tree.
7. Follow instructions in your operator's manual for starting the chain saw and control the chain saw with a firm grip on both handles when it is in operation. Keep handles dry, clean and free of oil. A chain saw should never be carried with the engine running.
8. When transporting your chain saw, use the appropriate transportation covers that should be available for the guide bar and saw chain.
9. Never operate a chain saw that is damaged or improperly adjusted or that is not completely and securely assembled. Be sure that the saw chain stops moving when the throttle control trigger is released. Never adjust the guide bar or saw chain when the engine is operating.
10. Beware of carbon monoxide poisoning. Operate the chain saw in well ventilated areas only.
11. Do not attempt a pruning or limbing operation in a standing tree unless specifically trained to do so.
12. Guard against kickback. Kickback is the upward motion of the guide bar that occurs when the saw chain, at the nose of the guide bar, contacts an object. Kickback can lead to dangerous loss of control of the chain saw.
13. Allow your chain saw to cool before refuelling, and do not smoke.
14. Don't allow other persons or animals close to a running chain saw or close to where a tree is being felled.
15. Use extreme caution when cutting small size brush and saplings because slender material may catch the saw chain and be whipped toward you.
16. When cutting a limb that is under tension be alert for spring-back.
17. This gas powered saw is classified by CSA as a class 1A saw.

Key to symbols

STIHL[®] **MODEL: XXX** **CLASS: XX**  **CAN 3-Z 62.1**
CAN 3-Z 62.3

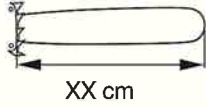
 XX cm  XXXX
 XXXXX  XX°/XX°
 XX°/XX°  

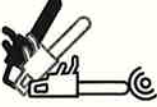
© Andreas Stihl XXXX

 <p>XX cm</p>	<p>Guide bar length</p>
	<p>Chain type</p>
	<p>Kickback angle, with/without chain brake</p>
	<p>Contact of the guide bar tip with any object should be avoided</p>
	<p>Always use two hands when operating the chain saw</p>



englisch/english